

THERMOSALD

ISX - IPX

A MODULAR SYSTEM
FOR
IMPULSE SEALING

NEW TECHNICAL FEATURES

THERMOREGULATOR CONFIGURABILITY
LOW VOLTAGE SUPPLY
PRECISION CALIBRATION PROBE
WORKING VOLTAGES FROM 230 TO 600 VOLTS
WORKING CURRENTS FROM 10 TO 500 AMPERE
IP65 PANEL
COPROCESSOR OPTION
PROFIBUS OPTION AND OTHER FIELD BUSES
ON-BOARD PLC OPTION WITH SEALING TIMES
MAXIMUM TEMPERATURE ALARM PROBE
CALIBRATING UP TO -30°C

OTHER FEATURES

COMPLETELY AUTOMATIC CALIBRATION
ON-LINE THERMOREGULATOR SIZING
BEST DIAGNOSTICS FOR TROUBLESHOOTING
ALPHANUMERIC DISPLAY IN 6 LANGUAGES
COMPATIBILITY WITH ALL PREVIOUS MODELS

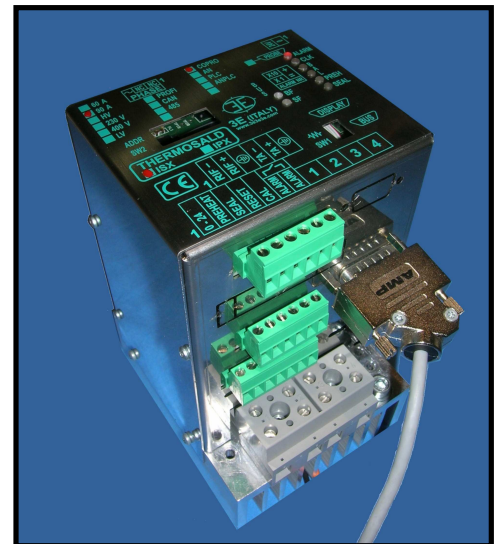

INSTALLATION AND USER MANUAL (V2)

3E S.r.l. - Via del Maccabreccia 37/a - 40012 LIPPO DI CALDERARA (BOLOGNA)

Tel. ++39 051 6466225-228

Fax ++39 051 6426252

E-Mail: mail@3e3e3e.com

Pagina web: www.3e3e3e.com

1	INTRODUCTION	4
2	SAFETY INSTRUCTIONS AND CERTIFICATIONS	5
2.1	SAFETY INSTRUCTIONS	5
2.2	COMPLIANCE WITH STANDARDS – CE MARKING	5
3	DESCRIPTION	6
3.1	INTRODUCTION ON THE MARKET	6
3.2	DESCRIPTION OF THE PRODUCT AND ADVANTAGES	6
3.3	OPERATING PRINCIPLE AND ADVANTAGES	7
3.4	APPLICATIONS	7
3.5	CONFIGURABILITY AND ADVANTAGES	8
4	INSTALLATION	11
4.1	WARNINGS AND REQUIREMENTS FOR INSTALLATION	11
4.2	COMPONENT SELECTION AND TECHNICAL NOTES FOR INSTALLATION	11
4.2.1	SECONDARY/PRIMARY THERMOREGULATOR	11
4.2.2	POWER TRANSFORMER AND SIZING	11
4.2.3	SIZING THE PROTECTION DEVICES	12
4.2.4	ELECTROMECHANICAL SYSTEM	12
4.2.5	MAINS FILTER	12
4.2.6	WIRING	13
4.2.7	INSTALLATION	14
4.3	WIRING DIAGRAMS	15
4.3.1	DIGITAL SIGNAL CONNECTIONS	15
4.3.2	CONTROL ON THE SECONDARY – POWER CONNECTIONS (THERMOSALD ISX MODEL)	16
4.3.3	CONTROL ON THE PRIMARY – POWER CONNECTIONS (THERMOSALD IPX MODEL)	17
4.3.4	LOW COST WITH POTENTIOMETERS OR ANALOGUE OUTPUTS FROM PLC (THERMOSALD ISX1-IPX1 MODEL)	18
4.3.5	STANDARD WITH OPERATOR PANEL (THERMOSALD ISX2-IPX2 MODEL)	19
4.3.6	STANDARD WITH PROFIBUS / RS485 (THERMOSALD ISX2-IPX2 MODEL + OPERATOR PANEL OPTION)	20
4.3.7	STANDARD WITH CAN BUS (THERMOSALD ISX2-IPX2 MODEL + OPERATOR PANEL OPTION)	21
4.3.8	STANDARD WITH PLC-ANALOGUE OPTION (THERMOSALD ISX2-IPX2 MODEL + OPERATOR PANEL OPTION)	22
4.4	LIST OF EXCHANGE SIGNALS	23
5	COMMISSIONING	26
5.1	COMMISSIONING WARNINGS	26
5.2	THERMOSALD ISX-LC – IPX-LC (LOW COST secondary - primary)	26
5.3	THERMOSALD ISX – IPX (STANDARD+ MULTILANGUAGE PANEL)	27
5.4	THERMOSALD ISX – IPX (+ ANALOGUE OPTION)	28
5.5	INSTRUCTIONS FOR USING THE MULTILANGUAGE PANEL	29
5.5.1	Homepage – (WARN 33 shows that there is no power on the input terminals)	29
5.5.2	Master Reset Page	29
5.5.3	Calibration Page	30
5.5.4	PARAMETERS Pages (structure and notes of the parameters contained in the submenus)	30
6	MAINTENANCE	32
6.1	REPLACING THE BAND WITH THE MACHINE COLD (i.e. bars at ambient temperature – scheduled maintenance)	32

6.2	REPLACING THE BAND WITH THE MACHINE HOT(i.e. bars at operating temperature - quick intervention).....	32
6.3	THERMOREGULATOR MAINTENANCE	32
6.4	GRIPPER JAWS MAINTENANCE	32
7	TECHNICAL DATA	33
7.1	TECHNICAL DATA FOR THE MODULATION-ON-THE-SECONDARY MODEL.....	33
7.2	TECHNICAL DATA FOR THE MODULATION-ON-THE-PRIMARY MODEL.....	33
	<i>Errore. Il segnalibro non è definito.</i>	
8	ORDERING DATA.....	34
8.1	CODES FOR ORDERING.....	34
8.2	SUGGESTIONS FOR CHOOSING THE MODEL.....	36
8.3	POSSIBLE CONFIGURATIONS.....	36
8.4	ORDER EXAMPLES	36
	APPENDIX A – SEALING CYCLE	38
	APPENDIX B - MACHINE DATA LIST	39
	APPENDIX B1 – PRIORITY MACHINE DATA managed directly on the MAIN MENU	40
	APPENDIX C - SETTING DATA LIST	41
	APPENDIX D – LIST OF ALARMS AND MESSAGES (CAUSES – REMEDIES).....	42
	APPENDIX E – MECHANICAL DIMENSIONS.....	51
	APPENDIX F – TABLE OF BANDS	52
	APPENDIX G – COMMISSIONING SHEET	53

1 INTRODUCTION

This manual is the only complete document concerning the product represented on the front page. It contains safety instructions, a description of the device and some of its possible applications, instructions for installing, commissioning, servicing and disposing of the product, the codes and some examples for placing orders.

This manual is referred to in all the documents that accompany the product and must be consulted before using the product described.

In particular, read the instructions related to safety, installation, commissioning, servicing and disposal before using the product.

REVISION OF THE MANUAL:

Rev.: 0 Data: 21/07/2010

2 SAFETY INSTRUCTIONS AND CERTIFICATIONS

2.1 SAFETY INSTRUCTIONS

- *A proper specific and technical knowledge is required to install, commission, service or use the product. Consult this “USER MANUAL” and follow the instructions contained herein in compliance with the SAFETY REGULATIONS.*
- *Improper use of the apparatus may result in dangerous conditions for the operator and things and people nearby.*
- *Do not use the equipment in an explosive atmosphere or with explosive material.*
- *Do not use the equipment with flammable material without first taking the necessary safety precautions.*
- *Install and use the thermoregulator only in industrial applications.*
- *Use bands or wires with an appropriate positive temperature coefficient ($\geq 8 \times 10E-4$, 800ppm/K).*
- *Do not change the temperature coefficient unless you have sufficient know how.*
- *Mechanically fix the thermoregulator to the plate using the fixing holes.*
- *Before connecting it to the mains, connect the ground protection conductor to the fixing bolt which is identified by a yellow-green PE indicator on the heat sink.*
- *Do not connect the power circuit of the thermoregulator when the machine’s mechanical guards are open.*
- *Do not power the thermoregulator if the protective cover has been removed.*
- *After a MASTER RESET procedure has been performed, set the parameters correctly before using the equipment.*

2.2 COMPLIANCE WITH STANDARDS – CE MARKING

The device complies with the fundamental requirements set forth in the following European Directives that apply to the product with reference to the harmonized standards below:

*89/336/EEC EMC Directive and subsequent amendments 92/31/ECC and 93/68/EEC
CEI EN 55022 – Electromagnetic Compatibility (EMC) –*

Emission for industrial environments

*CEI EN 61000-6-2 – Electromagnetic Compatibility (EMC) – Part 6-2: Generic Standards -
Immunity for industrial environments*

73/23/EEC /LOW VOLTAGE Directive and subsequent amendments 93/68/EEC

*CEI EN 60204-1 – Safety of machinery – Electrical equipment of machines
Part 1: General requirements*

3 DESCRIPTION

3.1 INTRODUCTION ON THE MARKET

THERMOSALD ISX – IPX is a modular line of products that can be configured and are compatible with one another. This line has been designed to meet all demands in the IMPULSE SEALING market. THERMOSALD ISX – IPX springs from the company's long experience in the impulse sealing field and maintains total compatibility with all previous thermoregulators, namely THERMOSALD PWM, THERMOSALD SCR, THERMOSALD UPSCR and THERMOSALD ISC.

3.2 DESCRIPTION OF THE PRODUCT AND ADVANTAGES

Like the previous impulse thermoregulators, THERMOSALD ISX – IPX can quickly heat a sealing band or cutting/sealing wire to the set temperature without using additional probes. This technology makes it possible to obtain very high working speeds for sealing polyethylene, polypropylene, environment-friendly products and plastics in general.

The temperature is controlled directly on the sealing line and the temperature can be maintained even at high speeds. It avoids temperature drift between the first sealing operation and the next ones in production, it prevents the support bars from overheating, thus avoiding any subsequent mechanical problems caused by expansion. A cooling air blow and other precautions may further increase the speed and improve the sealing quality.

Below is a list of the most important functional-technical features of the new THERMOSALD ISX – IPX product in the following order: first the new features of this new model, than the features inherited from the previous ones.

- *24VNS insulated POWER SUPPLY: in the THERMOSALD ISX version with control on the secondary, it allows the same thermoregulator to be used regardless of the mains voltage.*
- *TEMPERATURE PROBE: it allows the band drift to be corrected over time*
- *POWER TRANSFORMER CONTROL ON THE SECONDARY OR PRIMARY: it allows the User to choose the best solution to the problem he/she has to solve within a voltage range of 230 to 600 Volts or current range of 150 to 600 Ampere.*
- *CONFIGURATION FREEDOM: it allows the user to choose the right model, from the less expensive one which is COMPLETELY ANALOGUE, to the most expensive and sophisticated model with COPROCESSOR and MODBUS RS485 FIELDBUS, PROFIBUS, CAN and others.*
- *IP65 OPERATOR PANEL:*
- *ON-BOARD PLC: it allows the thermoregulator to be used with times and internal logics for totally controlling small-sized semi-automatic sealing machines.*

- **COMPATIBILITY WITH ALL PREVIOUS THERMOREGULATORS:** that allows spare parts to be replaced on obsolete models

- Current sensor towards ground: to stop the machine in the case of an earth leak of the band to ground and subsequent sealing malfunction.
- COMPLETELY AUTOMATIC CALIBRATION: just press the calibration button to calibrate, without selectors or trimmers
- GUIDED SIZING OF THE POWER TRANSFORMER: the only sizing required is that of the power transformer which can be done with the aid of a guided menu on the display panel: the user enters the band data and the thermoregulator suggests the voltage, current and power of the transformer to be used
- ON-LINE ANALYSIS OF THE RESISTANCE, VOLTAGE AND CURRENT VALUES OF THE BAND: the equipment allows the theoretical, commissioning and run-time values of the resistance, voltage, current and power to be displayed and compared so as to help the operator troubleshoot any machine problems
- BEST DIAGNOSTICS FOR TROUBLESHOOTING: powerful diagnostics warns the user of any problem that has occurred on the machine, from a wiring mistake during installation to a failure problem during standard operation
- ALPHANUMERIC DISPLAY IN 6 LANGUAGES

3.3 OPERATING PRINCIPLE AND ADVANTAGES:

At all network cycles THERMOSALD ISX – IPX reads the voltage and current on the band, calculates the resistance and then the temperature, which depends on the resistance, and controls the current that heats the band in a closed loop; this current is generated by a power transformer by means of phase control performed on the secondary of the power transformer in the THERMOSALD ISX configuration and on the primary of the power transformer in the THERMOSALD IPX configuration: selection can be made according to machine requirements or company situations.

The new structure of the thermoregulator allows the user to operate without virtually having voltage or current limits as the problem shifts completely on to the power transformer and the system technical standards. For further information and details please refer to paragraph CONFIGURATIONS AND ADVANTAGES below.

3.4 APPLICATIONS

On all packaging machines that require polyethylene, polypropylene, environment-friendly and plastic films to be sealed or cut/sealed, vertical and horizontal filling machines, bundling machines, shoppers, vacuum machines, etc.

3.5 CONFIGURABILITY AND ADVANTAGES

The thermoregulator that best suits machine requirements can be built with the same basic dimensions, 120mm x 100mm.

MODEL	FEATURES	ADVANTAGES
	- completely analogue	Low cost
THERMOSALD ISX - LC (LOW COST secondary)	- control on the secondary -one model for all mains -for output currents up to 250A	- It can be used with other mains from 230V to 600V without changing the thermoregulator model
THERMOSALD IPX - LC (LOW COST primary)	- control on the primary -change of model in case of 400V mains change -for output currents up to 300A	- Very high currents for very large bands

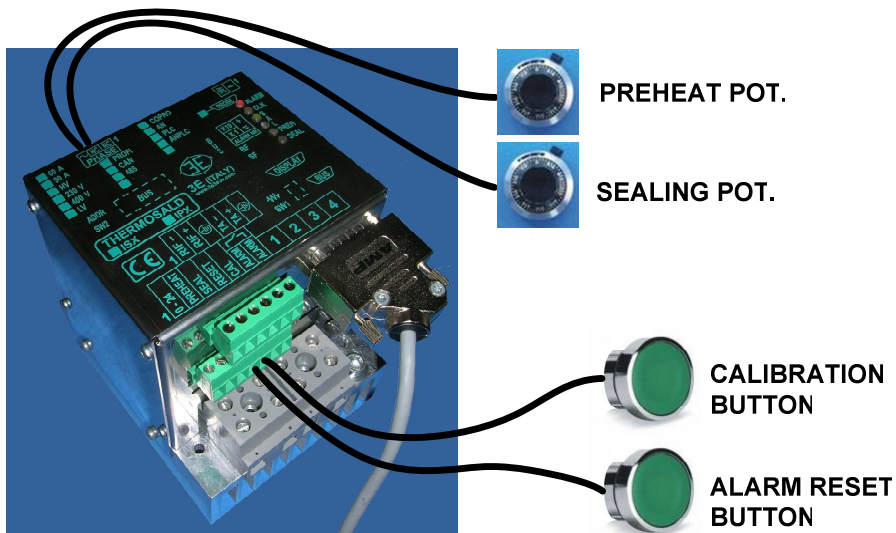

MODEL	FEATURES	ADVANTAGES
	120 x 100 H=130 -completely digital -precision sensor for zero point calibration -temperature sensor on power module	-Digital temperature settings -Powerful Diagnostics -Sealing parameter change -It allows the band drift to be compensated
THERMOSALD ISX + PANEL (standard secondary)	- control on the secondary -one model for all mains - for output currents up to 280-400A	- It can be used with other mains from 230V to 600V without changing the thermoregulator model
THERMOSALD IPX + PANEL (standard primary)	- control on the primary -change of model in case of 400V mains -for output currents up to 400A	- Possible implementations even with very high currents for very large bands

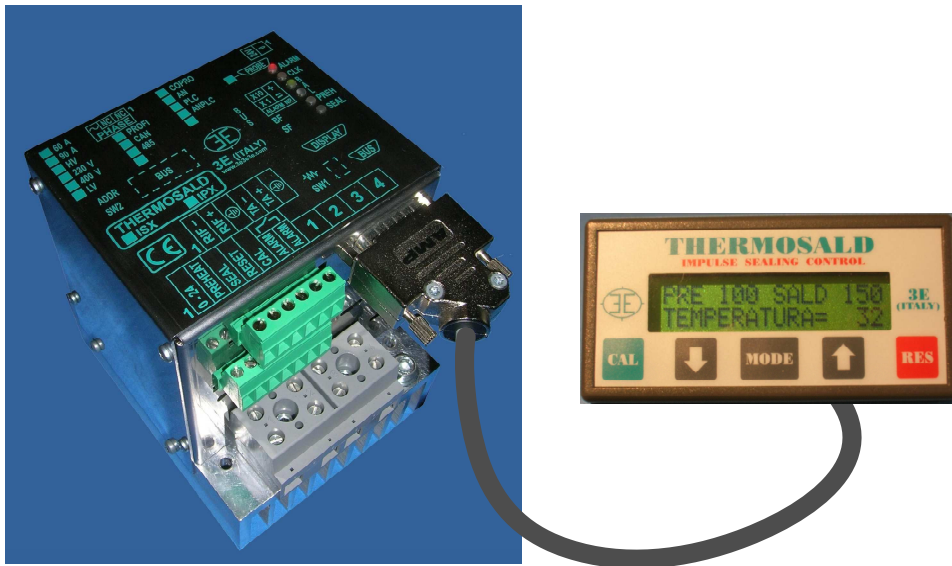

MODEL	FEATURES	ADVANTAGES
	120 x 100 H=170 -completely digital -precision sensor for zero point calibration -temperature sensor on power module – Coprocessor Option -RS485 Modbus Option -Profibus Option -Can bus Option -Analogue Option -Sealing Times and PLC Option	-Digital temperature settings -Powerful Diagnostics -Sealing parameter change -It allows the band drift to be compensated Maximum flexibility
THERMOSALD ISX + PANEL +OPTIONS (secondary+options)	- control on the secondary -one model for all mains - for output currents up to 280-400A	- It can be used with other mains from 230V to 600V without changing the thermoregulator model
THERMOSALD IPX + PANEL +IPX OPTIONS (primary+options)	- control on the primary -change of model in case of 400V mains -for output currents up to 400A	- Possible implementations even with very high currents for very large bands

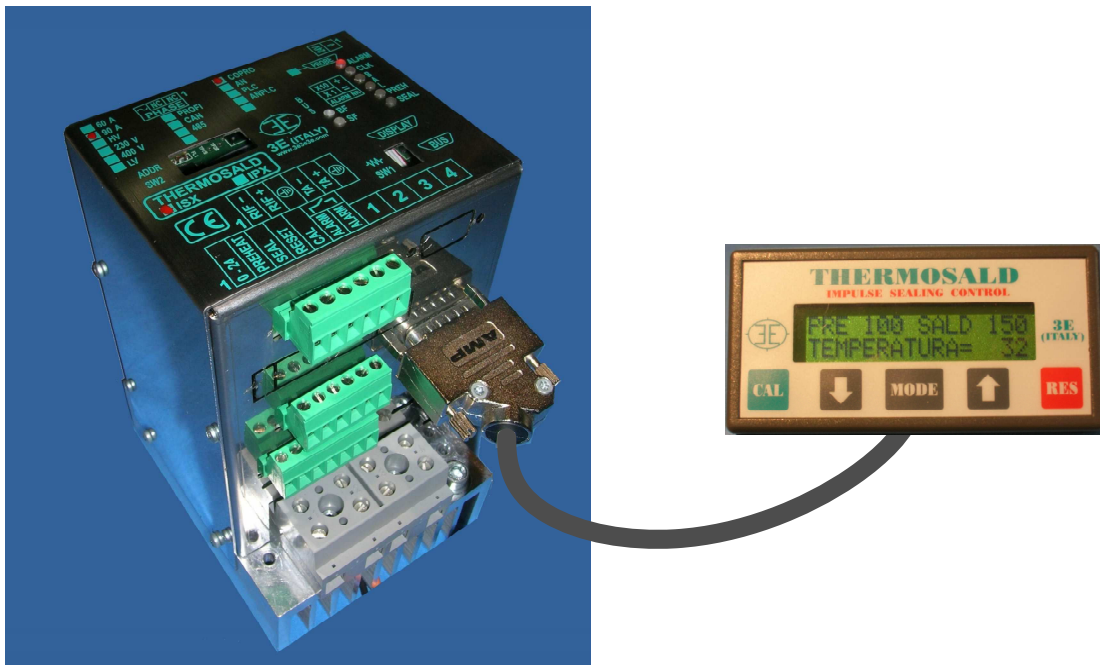

4 INSTALLATION

4.1 WARNINGS AND REQUIREMENTS FOR INSTALLATION

- BEFORE STARTING to INSTALL carefully read the SAFETY WARNINGS contained in this manual.
- This apparatus must be installed in accordance with the requirements set forth in standard CEI - EN60204
- This apparatus must be installed carefully following the instructions contained in this USER MANUAL
- This apparatus must be installed by skilled and properly trained personnel

4.2 COMPONENT SELECTION AND TECHNICAL NOTES FOR INSTALLATION

(Please refer to the diagrams under paragraph 4.5)

Below are the calculations to define the voltage and current required for the best application; select the suitable THERMOSALD ISX-IPX from the order table according to the values calculated.

4.2.1 SECONDARY/PRIMARY THERMOREGULATOR

- The apparatus must be installed inside an electrical panel, protected against dust, water and corrosive acids.
- The apparatus does not require special ventilation when used, but must be installed in a properly ventilated area; when the machine reaches steady-state operation, check that the heat sink of the thermoregulator does not exceed 60°C, if so, increase ventilation; a safety temperature probe is installed in models ISX2 and IPX2.

4.2.2 POWER TRANSFORMER AND SIZING

- A power transformer suitable for the circulating currents must be envisaged to supply power to the sealing band as indicated in the diagrams (ref. par. 4.5); in the case of a overlapped winding transformer, place a shield between the primary and secondary to avoid mains leaks on the secondary

-The power transformer can be sized simply using the thermoregulator's panel (diagnosis menu – see description in the commissioning section) or as follows:
Calculate the band cross-section $CROSS-SECTION[sq.mm] = WIDTH[mm] \times THICKNESS[mm]$

Calculate rated heating current $I_{nom} [A] = 30[A/sq.mm] \times CROSS-SECTION[sq.mm]$

Calculate useful resistance $R_u[ohm] = Specific\ resistance[ohm/m] \times Useful\ length [m]$

Calculate the rated voltage and power

$V_{nom}[V] = R_u[ohm] \times I_{nom} [A]$, $P_{nom} = V_{nom} \times I_{nom}$.

Follow the suggestions of the notes below:

NOTE1: maximum theoretical voltage VT and current IT of the transformer are calculated according to the machine's speed requirements: a coefficient x 1.5, x 2, i.e. VT=Vnom x coefficient, IT=Inom x coefficient, can be applied.

NOTE2: the maximum theoretical power of the transformer is calculated without considering the first full-wave heating impulses and according to a phase modulation mean factor, $PT = VT \times IT \times 0.7$

NOTE3: the actual mean power of the transformer depends on the number of sealing operations per minute, the ratio between the active state and sealing cycle period and the thickness of the film to be sealed; due to overall dimension reasons and costs, the PT theoretical power can be declassified introducing a SIF intermittent duty-type of the transformer (which, according to experience, should be about 50%-40%).

4.2.3 SIZING THE PROTECTION DEVICES

Envisage a D CURVE protection thermal magnetic circuit breaker to disconnect the mains as indicated in the diagrams (ref. par. 4.5).

Calculate the breaking current = theoretical heating current IT divided by secondary-primary coils ratio Q.

Ithermal magnetic circuit breaker = IT / Q

NOTE1: the value of the protection device of the power transformer's secondary must be the same as or higher than the calculated theoretical current IT; this protection device trips on the cables and band downstream of it. Considering that the thermoregulator is already fitted with an electronic protection device on the cables' and band's current, the fitter should analyze the possibility of not installing said protection device on the basis of the application.

NOTE2: please note that the suggested protection devices must be verified by the designer according to the application.

4.2.4 ELECTROMECHANICAL SYSTEM

-The safety chain must be made like the one in the base drawing (ref. par. 4.5). the emergency output contact must interrupt the power electromechanically; in particular, it must open the contactor necessary for interrupting the power transformer's power supply. this contact must be suitable for the circulating currents; this interruption is crucial because if the electronic switch inside the thermoregulator fails (very rare event), only the contactor can prevent the bands from overheating and breaking.

- Install an emergency button as indicated in the diagrams (ref. Par. 4.5). It must only be possible to reset this button manually and must be placed in a non-dangerous area that the operator can access easily.

4.2.5 MAINS FILTER

-No cases of interference with equipment nearby have occurred with THERMOSALD ISX, phase control on the secondary. The system designer has to decide whether or not one single filter should be fitted at the input of the system for the entire machine according to the emission measurements taken on the mains.

-A mains filter is recommended for THERMOSALD IPX, phase control on the secondary. The system designer has to decide whether or not one single filter should be fitted at the input of the system for the entire machine according to the emission measurements taken on the mains.

4.2.6 WIRING

SINGLE BAND CONNECTION

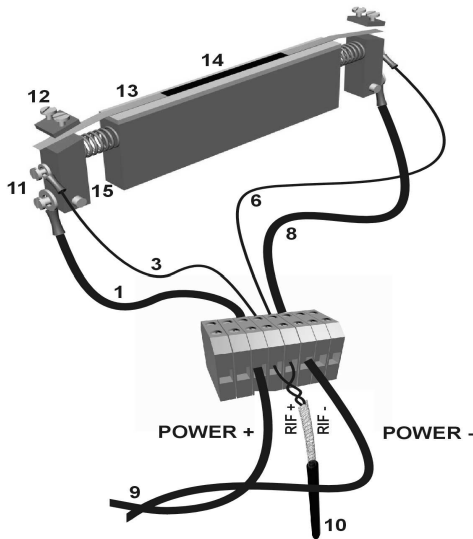

BAND CONNECTION IN PARALLEL

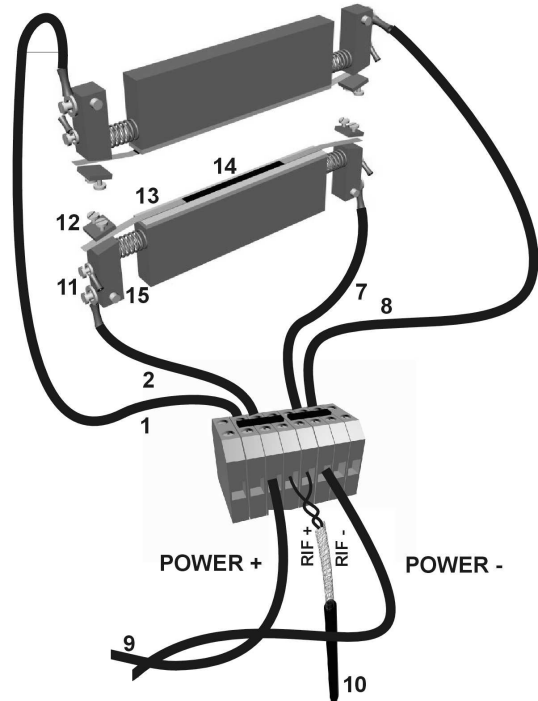

The apparatus must be installed inside an electrical panel, screwed on a iron plate zinc plated.

Warning: one end of the band's power circuit is connected to PE; this connection is made in the grey power terminal block CN1, terminals 2 and 3. Do not ground the band directly.

The transformer-thermoregulator cables must be twisted

The power cables to the band can be laid in a cable duct with other cables but must be twisted to avoid any interference. If other apparatus electrically much noise are in the plant it's possibly increase noise immunity using use shielded cables in compliance with EMC requirements.

Cable cross-section 10 sq.mm for bands with a total cross-section ≤ 2.0 sq.mm (e.g. 2 bands in parallel 4 x 0.25)

16sq.mm for bands with a total cross-section > 2.0 sq.mm (e.g. 2 bands in parallel 6 x 0.3)

The reference cables must be shielded-twisted; for the best connection fix them directly on the terminals of a band. To increase the system's strength, and as our long experience has taught us, we recommend you to connect wire to a terminal near sealing bands as indicated in the adjacent drawings.

Set the wiring so as to obtain 1 independent box with the support terminal block for every thermoregulator so as to ensure that the cables of a thermoregulator do not get tangled with the cables of another thermoregulator or of another electrical noise units.

In compliance with EMC requirements MAINS FILTER is not necessary on the application

with control on the secondary

4.2.7 INSTALLATION

Electrically disconnect the electrical panel and make sure no voltage is being supplied to the mains connection terminals.

Screw the thermoregulator on the bottom of the electrical panel.

Connect the ground wire (with the same cross-section as the power cables) to the thermoregulator's PE bolt.

Wire the power cables as described previously.

Wire the reference cables as described previously.

Perform the safety chain as described previously.

4.3 WIRING DIAGRAMS

4.3.1 DIGITAL SIGNAL CONNECTIONS

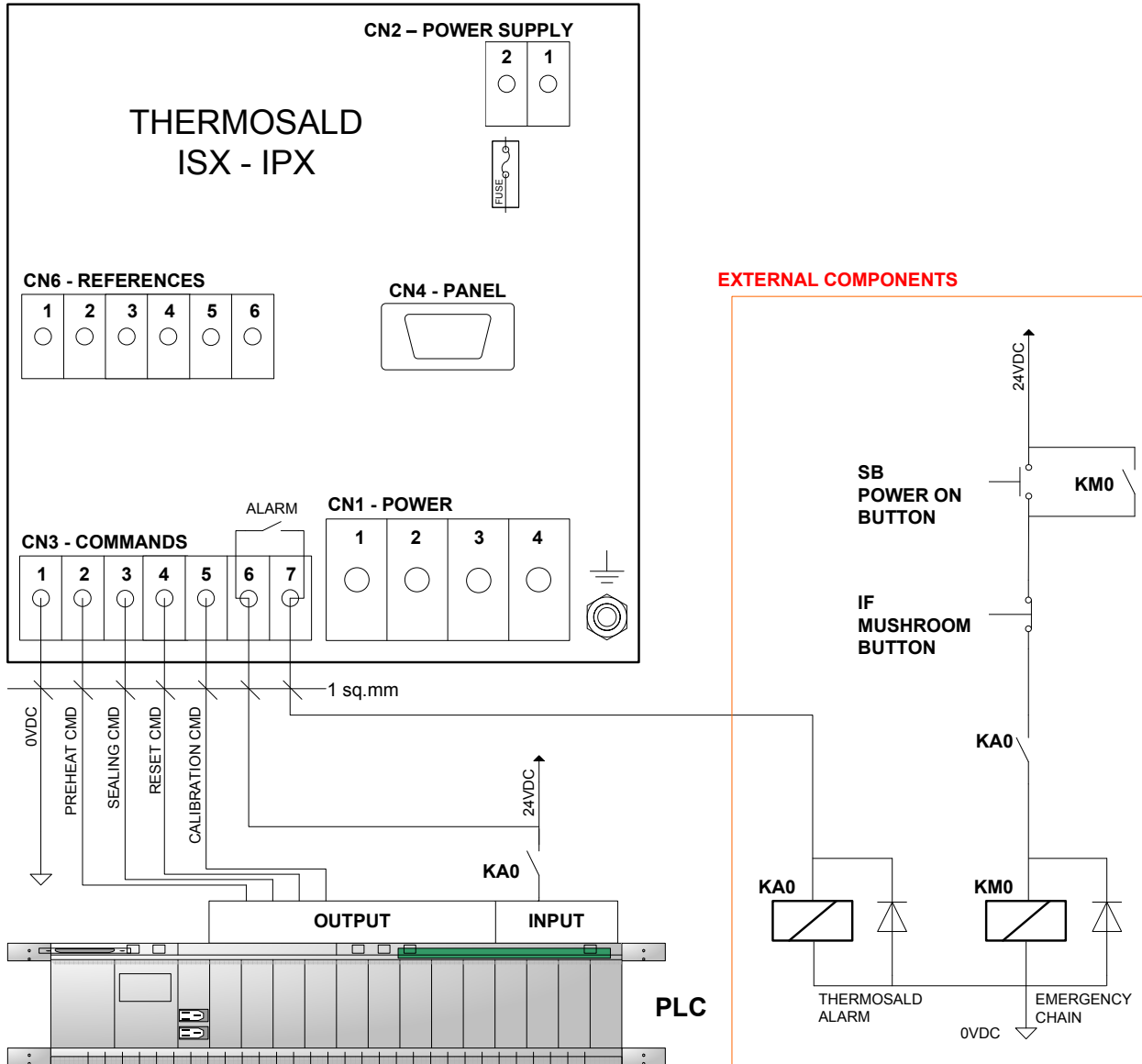

CONSTRUCTION NOTES:

4.3.2 CONTROL ON THE SECONDARY – POWER CONNECTIONS (THERMOSALD ISX MODEL)

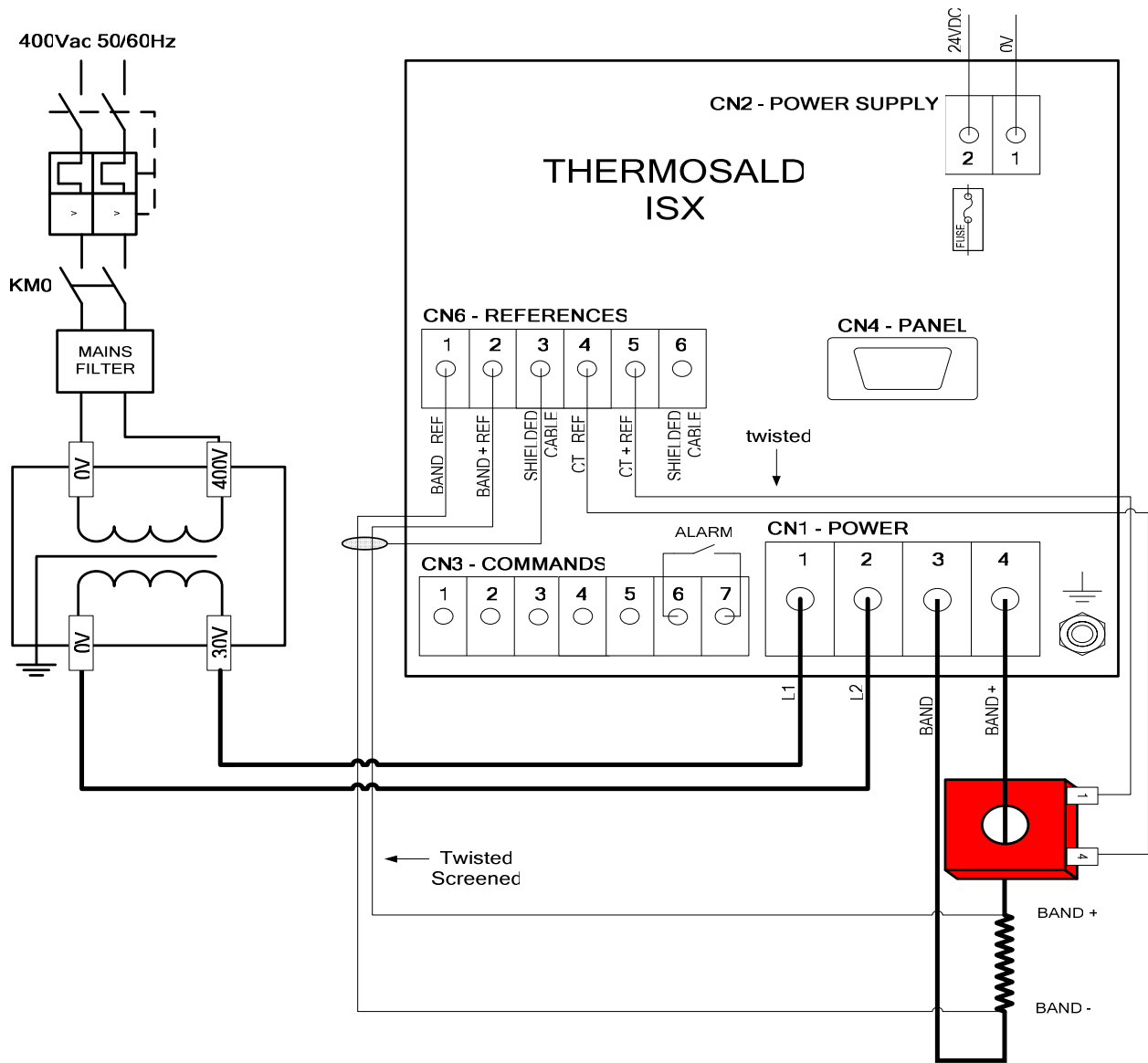

TECHNICAL NOTES:

In the case of the COPROCESSOR OPTION connector CN6 – References and the current transformer (CT) are doubled.

CONSTRUCTION NOTES:

4.3.3 CONTROL ON THE PRIMARY – POWER CONNECTIONS (THERMOSALD IPX MODEL)

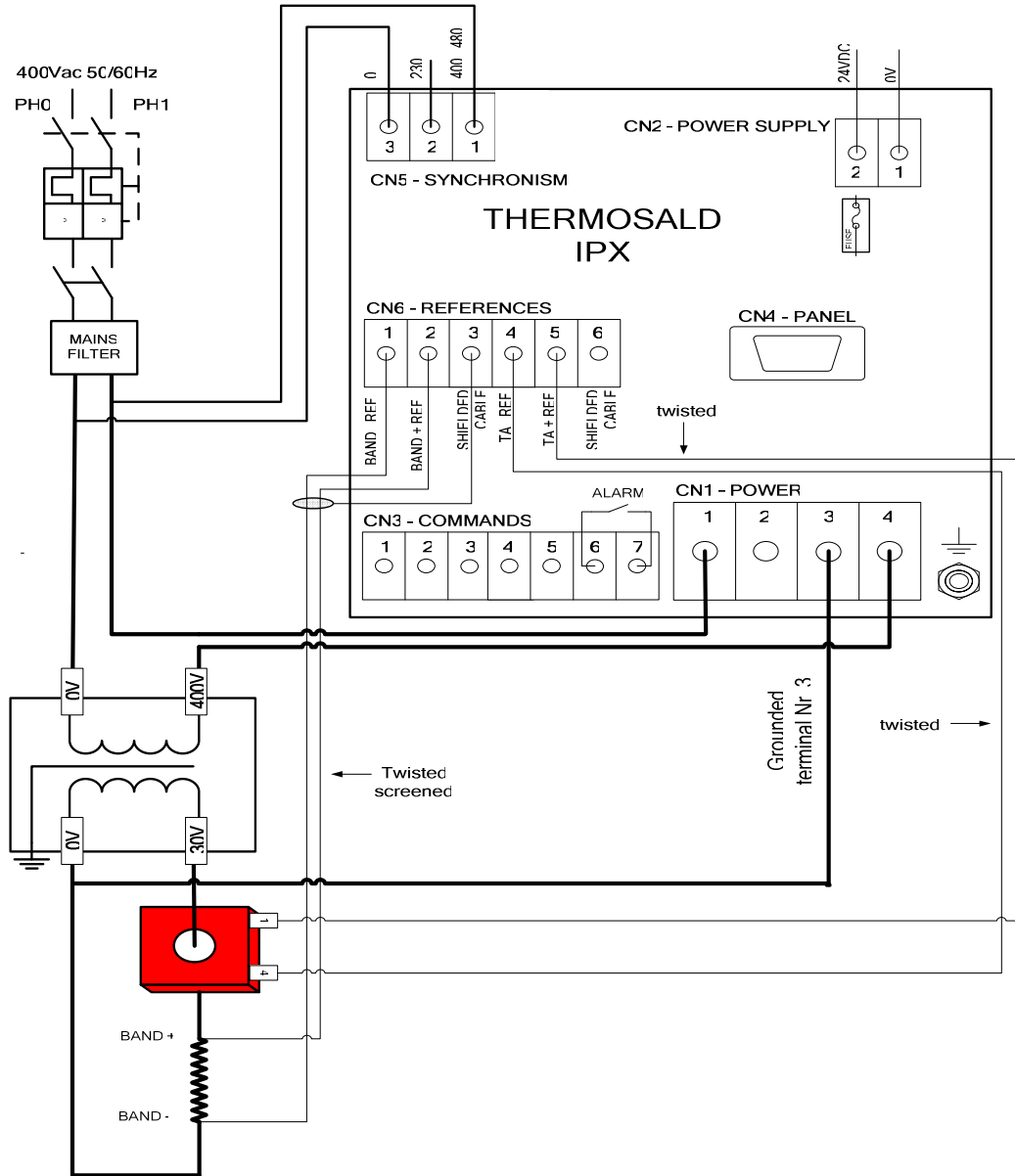

TECHNICAL NOTES:

In the case of the COPROCESSOR OPTION connector CN6 – References and the current transformer (CT) are doubled.

CONSTRUCTION NOTES:

4.3.4 LOW COST WITH POTENTIOMETERS OR ANALOGUE OUTPUTS FROM PLC (THERMOSALD ISX1-IPX1 MODEL)

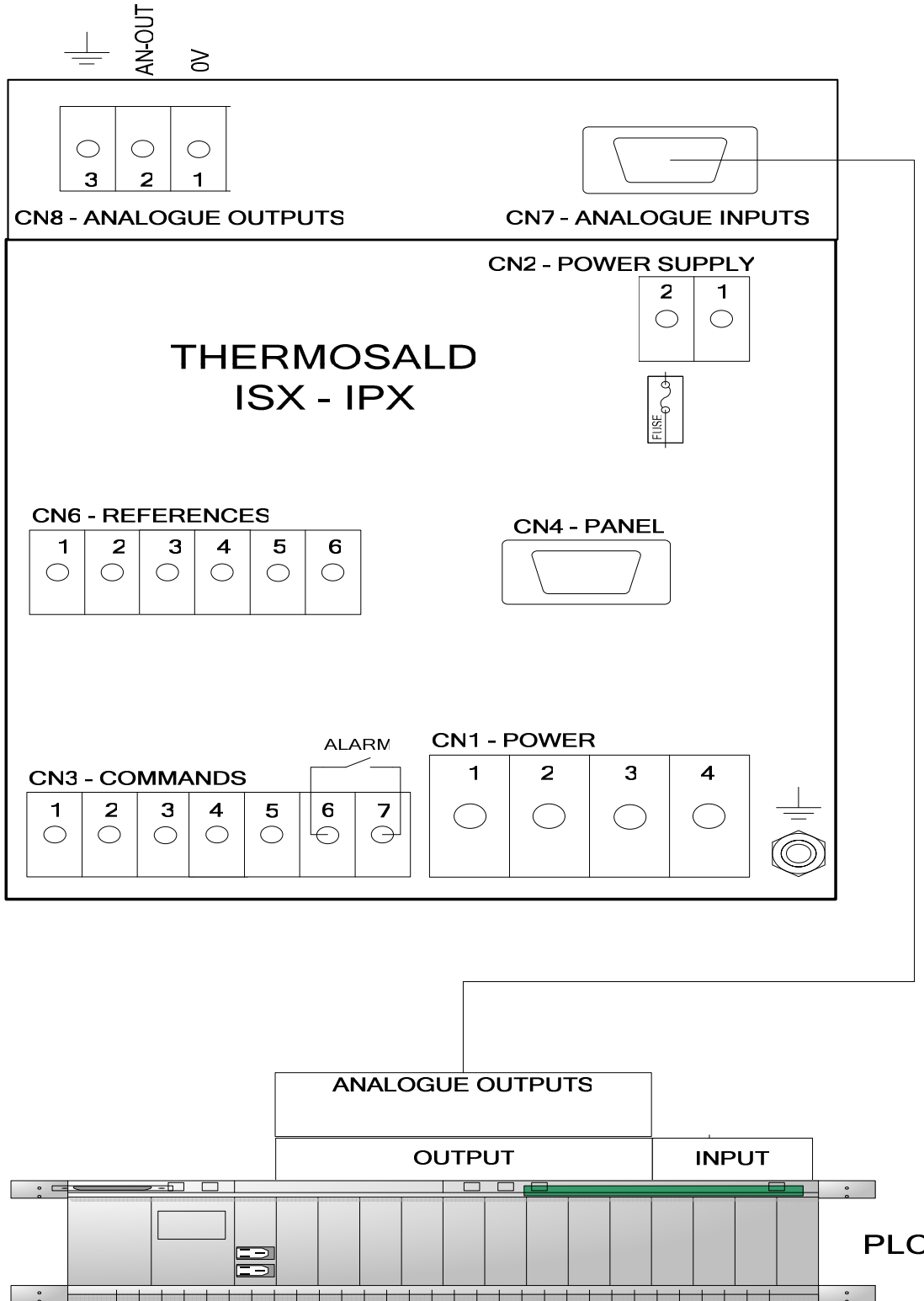

4.3.5 STANDARD WITH OPERATOR PANEL (THERMOSALD ISX2-IPX2 MODEL)

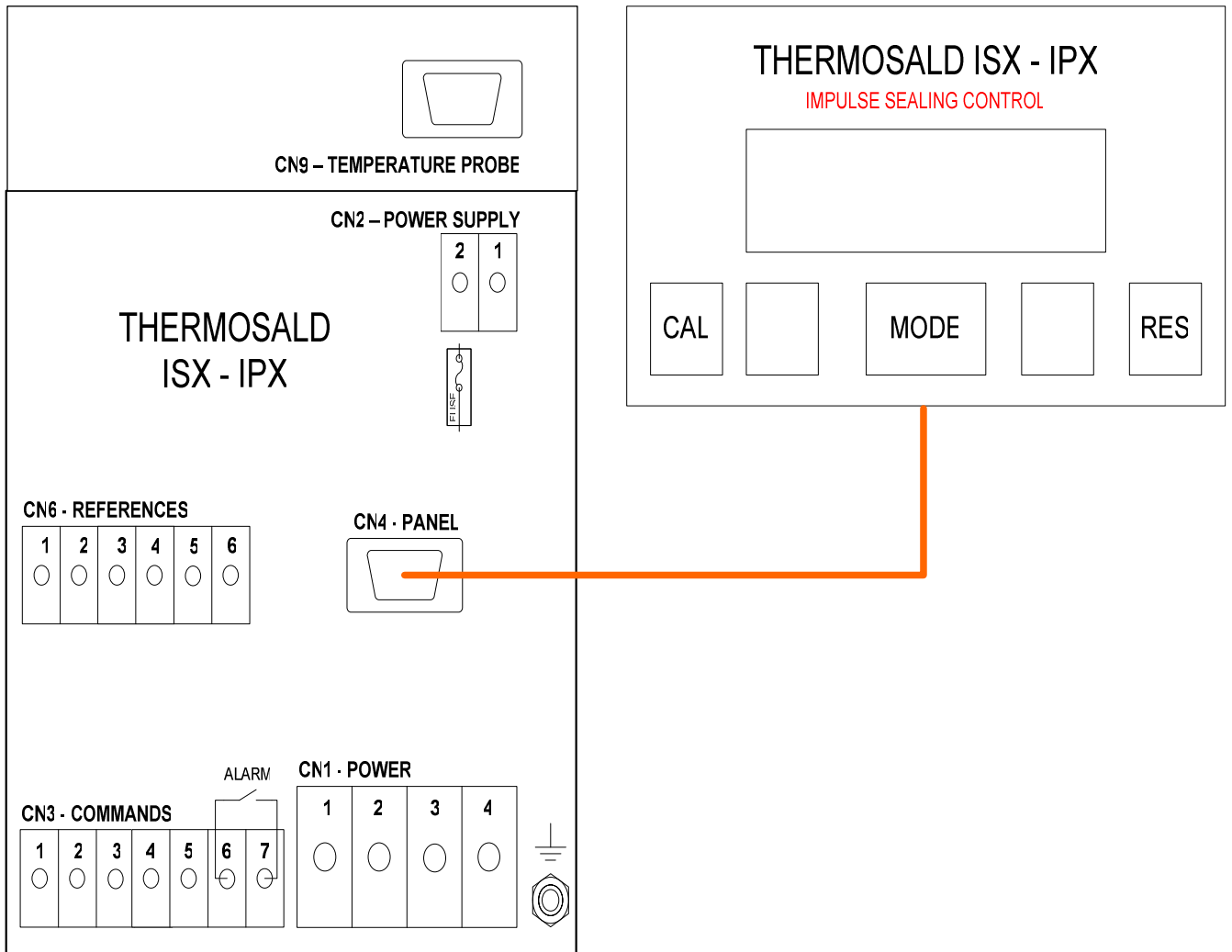

4.3.6 STANDARD WITH PROFIBUS / RS485 (THERMOSALD ISX2-IPX2 MODEL + OPERATOR PANEL OPTION)

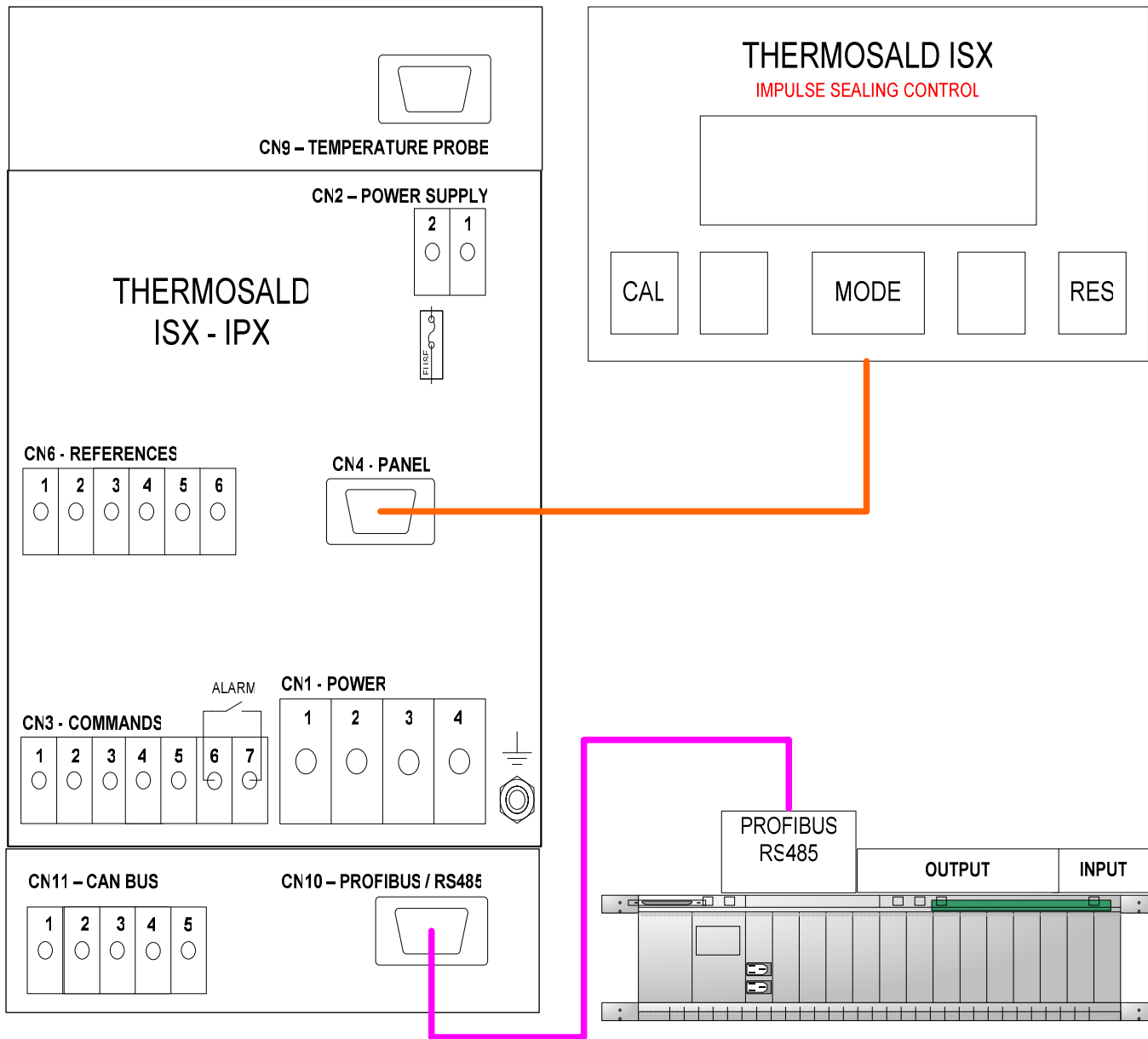

4.3.7 STANDARD WITH CAN BUS (THERMOSALD ISX2-IPX2 MODEL + OPERATOR PANEL OPTION)

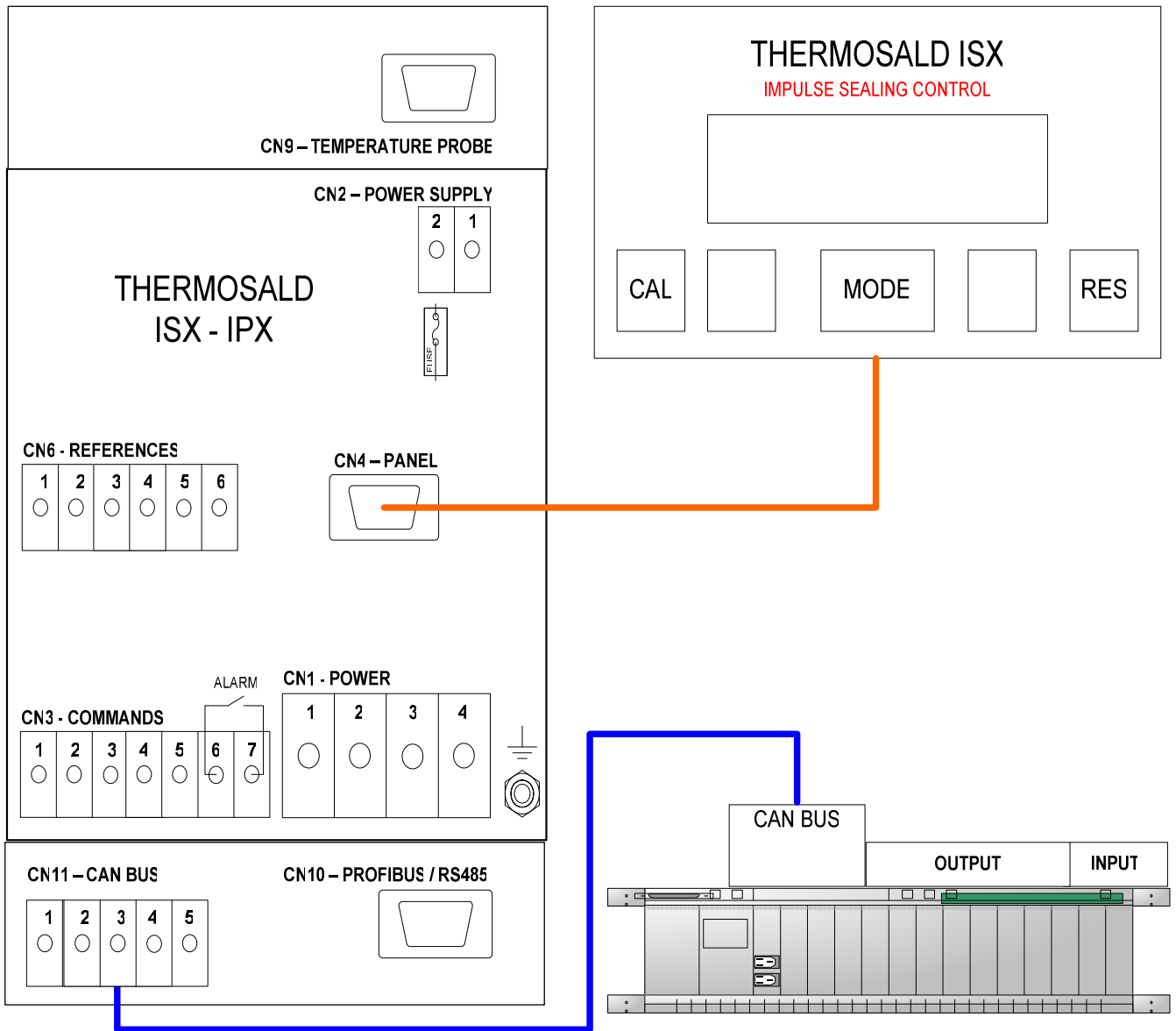

4.3.8 STANDARD WITH PLC-ANALOGUE OPTION (THERMOSALD ISX2-IPX2 MODEL + OPERATOR PANEL OPTION)

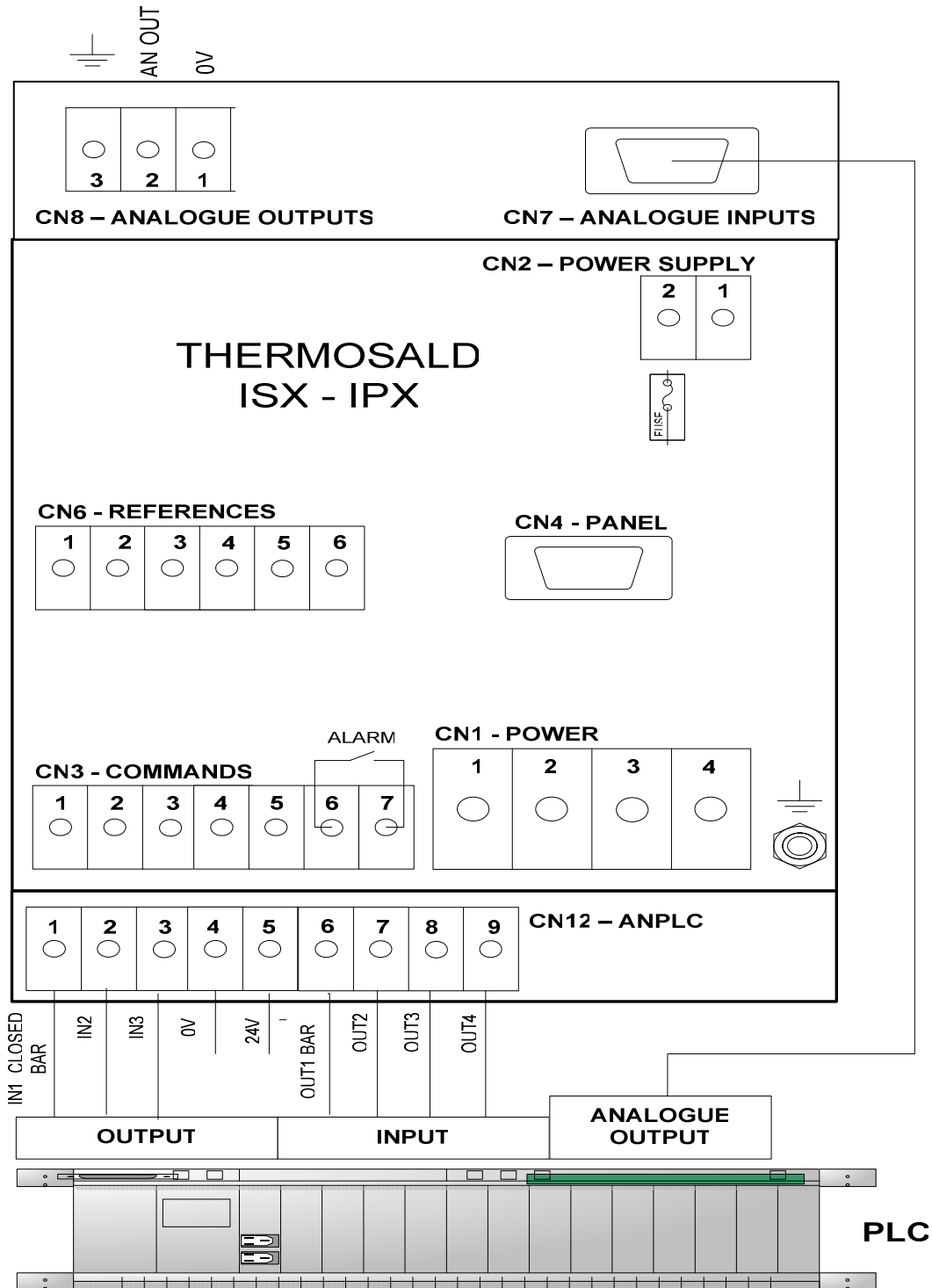

4.4 LIST OF EXCHANGE SIGNALS

This list specifies the list of the connections and related PINS of

CN1 – POWER TERMINAL BLOCK (MODEL WITH CONTROL ON THE SECONDARY)

PIN1	ALTERNATING POWER SUPPLY
PIN2	ALTERNATING POWER SUPPLY
PIN3	BAND -
PIN4	BAND +

NOTE1: We recommend you twist the power cables

CN1 – POWER TERMINAL BLOCK (MODEL WITH CONTROL ON THE PRIMARY)

PIN1	ALTERNATING POWER SUPPLY INPUT (230VAC)
PIN2	
PIN3	CONNECT TO 0V OF THE POWER SECONDARY TO CHECK GROUND CURRENT
PIN4	PHASED POWER SUPPLY OUTPUT TO THE PRIMARY OF TRANSFORMER

NOTE1: We recommend you twist the power cables

NOTE2: Alternating supply of the control circuit with the same phase as that of the power circuit

CN2 – CONTROL CIRCUIT POWER SUPPLY TERMINAL BLOCK

PIN 1	0 Vdc	(max absorption: 0.5 A)
PIN 2	24 Vdc	(max absorption: 0.5 A)

NOTE1: 0-24VDC is insulated from the internal power supply and ground

CN3 – COMMAND TERMINAL BLOCK

PIN1	0 V PLC COMMON (24 Vdc)	(max absorption: 0.1 A)
PIN2	PREHEATING COMMAND FROM 24 Vdc PLC (0)	(20 mA max)
PIN3	SEALING COMMAND FROM 24 Vdc PLC (0)	(20 mA max)
PIN4	RESET COMMAND FROM 24 Vdc PLC (0) DC	(20 mA max)
PIN5	CALIBRATION COMMAND FROM 24 Vdc PLC (0) DC	(20 mA max)
PIN6	SEALING ALARM (N.C. CONTACT)	(4 A max)
PIN7	SEALING ALARM (N.C. CONTACT)	(4 A max)

CN4 – CONNECTOR FOR DISPLAY PANEL (15 POLES, FEMALE)

PIN1	+5 Vdc	Shielded (0.25 sq.mm)
PIN2	0 V	Shielded (0.25 sq.mm)
PIN3	SPI-SDO	Shielded (0.25 sq.mm)
PIN4	SPI-SCK	Shielded (0.25 sq.mm)
PIN5	SPI-SDI	Shielded (0.25 sq.mm)
PIN6		
PIN7		
PIN8		
PIN9	SPI-SS	Shielded (0.25 sq.mm)
PIN10	DO NOT USE	Shielded (0.25 sq.mm)
PIN11	DO NOT USE	Shielded (0.25 sq.mm)

PIN12	DO NOT USE	Shielded (0.25 sq.mm)
PIN13	DO NOT USE	Shielded (0.25 sq.mm)
PIN14		
PIN15		

NOTE1: The thermoregulator-panel connection cable must be shielded with pin-to-pin connection. Max 15 m.

CN5 – PHASE INPUT TERMINAL BLOCK FOR SYNCHRONISM

PIN1	
PIN2	
PIN3	PH0 - Synchronism

CN6 – REFERENCE TERMINAL BLOCK

PIN1	REF- BAND REFERENCE	(1 mA max)
PIN2	REF+ BAND REFERENCE	(1 mA max)
PIN3	REF0 REFERENCE CABLE SHIELD (do not connect on the machine side)	
PIN4	CT- REFERENCE	(500 mA max) twisted cable
PIN5	CT+ REFERENCE	(500 mA max) twisted cable
PIN6	N.C.	

CN7 - POTENTIOMETER CONNECTOR (9 POLES, MALE)

PIN1	+4.5V PREHEAT POTENTIOMETER	(1 mA max)
PIN2	REF+ PREHEAT POTENTIOMETER	(1 mA max)
PIN3	0V PREHEAT POTENTIOMETER	(1 mA max)
PIN4	jumper PIN3 and PIN4	(1 mA max)
PIN5		
PIN6	+4.5V SEALING POTENTIOMETER	(1 mA max)
PIN7	REF+ SEALING POTENTIOMETER	(1 mA max)
PIN8	0V SEALING POTENTIOMETER	(1 mA max)
PIN9	jumper PIN8 and PIN9	(1 mA max)

NOTE1: if piloted from analogue PLC output, use PIN2,PIN3,PIN7,PIN8 and leave PIN4-PIN9 free.

NOTE2: REF-, REF+: we recommend you use a shielded twisted pair (e.g. TWINAX IBM cable, our code 3esd0066)

CN8 – ANALOGUE OUTPUT TERMINAL BLOCK

PIN 1	0 Vdc ANALOGUE	(5ma max)
PIN 2	0-5 Vdc ANALOGUE REFERENCE OUTPUT	(5ma max)
PIN 3	ANALOGUE REFERENCE OUTPUT CABLE SHIELD	

CN9 – TEMPERATURE PROBE CONNECTOR (9 POLES, FEMALE)

PIN1	0V	(1 mA max)
PIN2	+5 Vdc	(1 mA max)
PIN3		

PIN4		
PIN5		
PIN6		
PIN7	OUT CLOCK	(1 mA max)
PIN8		
PIN9	DATA	(1 mA max)

CN10 - PROFIBUS / 485 SERIAL CONNECTOR (9 POLES, FEMALE)

PIN1		
PIN2		
PIN3	Profibus B / Rs485 A+	
PIN4	Profibus Enable	
PIN5		
PIN6		
PIN7		
PIN8	Profibus A / Rs485 B-	
PIN9		

NOTE1: we recommend you use a shielded cable

CN11 – CAN BUS TERMINAL BLOCK

PIN1	CAN – V-	
PIN2	CAN L	
PIN3	0 V EXTERNAL (INSULATED)	
PIN4	CAN H	
PIN5	CAN – V+	

CN12 – ANPLC TERMINAL BLOCK

PIN1	0 V COMMON	
PIN2	IN0 Closed bar	(10 mA max)
PIN3	IN1	(10 mA max)
PIN4	IN2	(10 mA max)
PIN5	IN3	(10 mA max)
PIN6	IN4	(10 mA max)
PIN7	IN5	(10 mA max)
PIN8	IN6	(10 mA max)
PIN9	IN7	(10 mA max)
PIN10	24 Vdc COMMON	
PIN11	OUT0 CLOSED BAR	(0-500 ma)
PIN12	OUT1 BLOW	(0-500 ma)
PIN13	OUT2	(0-500 ma)
PIN14	OUT3	(0-500 ma)

5 COMMISSIONING

5.1 COMMISSIONING WARNINGS

-BEFORE STARTING COMMISSIONING carefully read the SAFETY WARNINGS and INSTALLATION WARNINGS in the USER AND INSTALLATION MANUAL this chapter is an integral part of or a copy of it.

-The system must have been sized as specified in the installation warnings and built in a workmanlike fashion.

-The thermoregulator is provided in the MASTER RESET condition. After every MASTER RESET the parameters return to the default status: if they were changed for operation purposes, the working parameters are to be set; in this case the 4 led on the equipment in the right are blinking.

-For any further information do not hesitate to contact 3E.

5.2 THERMOSALD ISX-LC – IPX-LC (LOW COST secondary - primary)

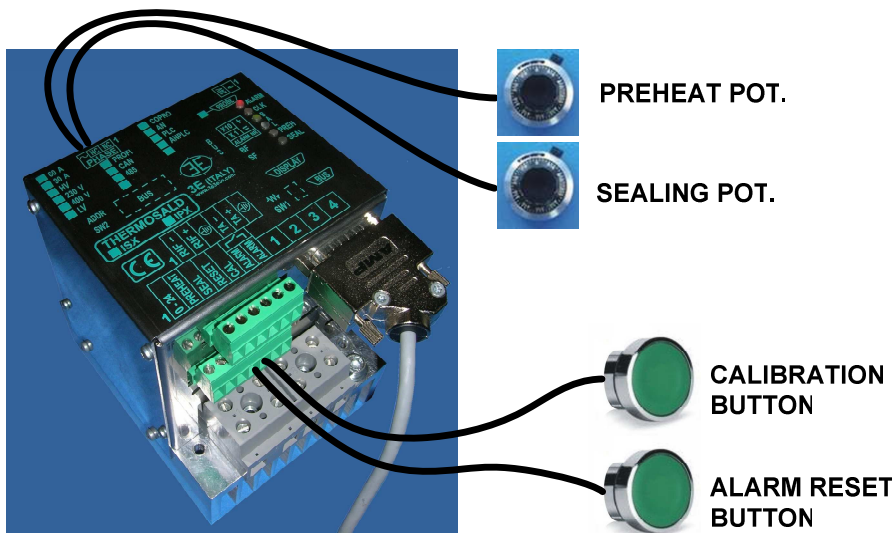

Step 1 – calibrate only after reading the commissioning warnings.

Step 2 – the machine must be at ambient temperature

Step 3 – the preheat and sealing commands must be deactivated

Step 4 – power the thermoregulator

Step 5 – in the event of an alarm, red ALARM LED on, follow the thermoregulator's suggestions and solve (the alarm number can be identified by counting the impulses of the green balance LED for tens – e.g. 9 impulses = 90 - + the impulses of the red balance LED for units – e.g. 10 impulses = 0).

Point 6 - calibrate: press the external CALIBRATION button and wait (the 2 LEDs on the equipment blink during calibration)

Step 7 – at the end of calibration the machine is ready to work: set the preheat and sealing temperature on the preheat and sealing potentiometers (30 degrees/turn)

NOTE 1: if calibration problems occur, perform a MASTER RESET and proceed from step 2 (to perform the MASTER RESET: keep the external RESET + CALIBRATION button pressed for 6 seconds; the 4 LEDs on the equipment remain on for 3 seconds).

5.3 THERMOSALD ISX – IPX (STANDARD+ MULTILANGUAGE PANEL)

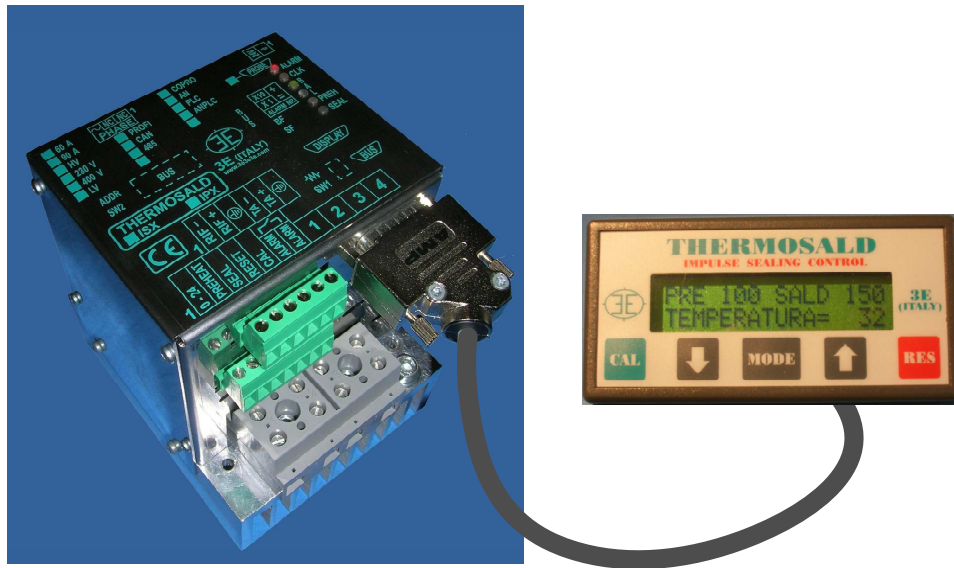

Step 1 – calibrate only after reading the commissioning warnings.

Step 2 – the machine must be at ambient temperature

Step 3 – the preheat and sealing commands must be deactivated

Step 4 – power the thermoregulator

Step 5 - in the event of an alarm, thermoregulator's red ALARM LED on, follow the panel's suggestions and solve (the alarm number and the description in the language selected among the 6 possible ones)

Point 6 - calibrate: keep the green CAL button on the multilanguage panel pressed for 3 seconds (the 2 LEDs on the equipment blink during calibration).

Step 7 – at the end of calibration the machine is ready to work; set the preheat and sealing temperature in the TEMPERATURE submenu as specified in paragraph 5.5.4.

Step 8 – Press the RES button and follow the instructions to go back to the homepage

NOTE 1: for the next calibrations press the CAL+MODE+CAL buttons on the multilanguage panel in sequence (see par. 5.5.3 Calibration Page)

NOTE 2: calibration can also be performed from outside, as described in paragraph 5.2 of the LOW COST configuration.

NOTE 3: if calibration problems occurs, perform a MASTER RESET according to one of the following procedures:

procedure 1 - Keep ARROW DOWN + ARROW UP on the multilanguage panel pressed for 6 seconds.

procedure 2 – Keep the external RESET + CALIBRATION buttons pressed at the same time for 6 seconds

The 4 LEDs on the equipment remain on for 3 seconds during the MASTER RESET.

5.4 THERMOSALD ISX – IPX (+ ANALOGUE OPTION)

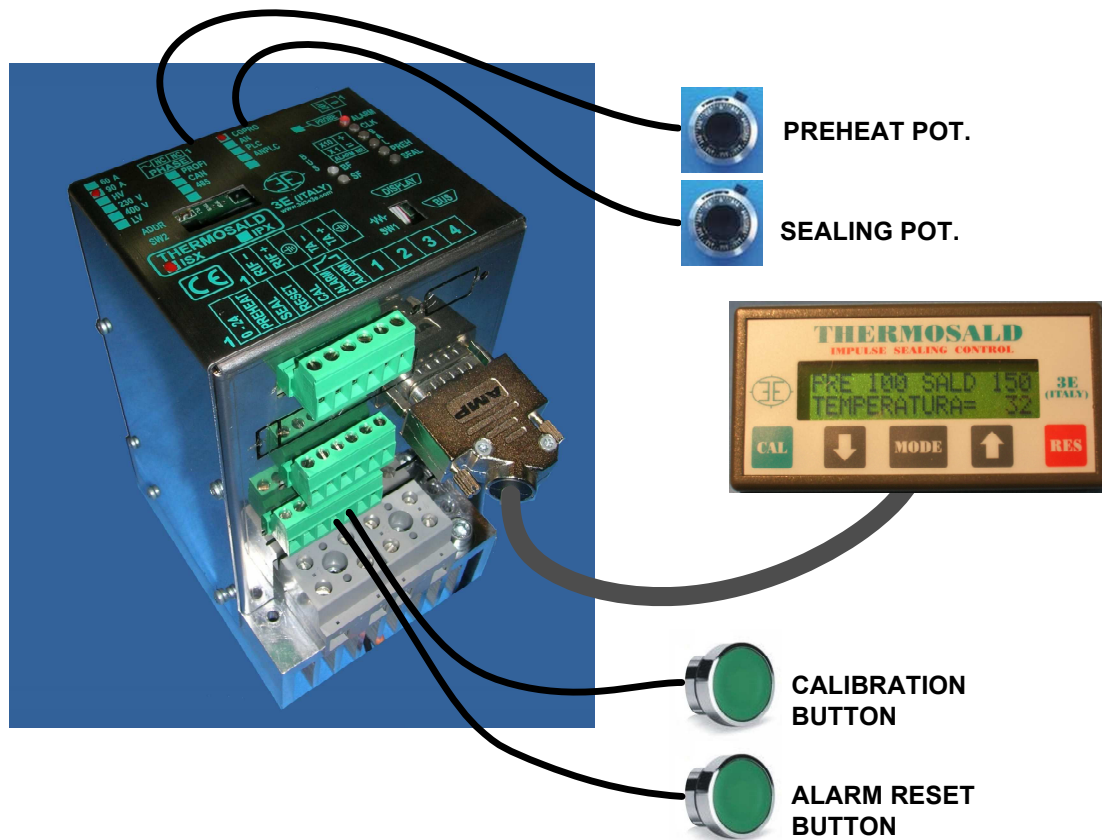

NOTE 1: set the CONFIGURATION MACHINE DATA=1 potentiometers+display to enable the potentiometers.

NOTE 2: set the maximum preheat and sealing temperatures on the panel and decrease them with the analogue inputs (with 30 degrees/turn potentiometers, with 13mV/degree analogue inputs).

NOTE 3: please refer to paragraph 5.3 for the other functions.

5.5 INSTRUCTIONS FOR USING THE MULTILANGUAGE PANEL

NOTE: It is possible to go back to the homepage from any page by pressing the RES button repeatedly.

NOTE: Press the MODE button to access the LEVEL 2 submenu pages and then the ARROW DOWN ▼ and ARROW UP ▲ buttons.

NOTE: Any parameter displayed can be changed as follows:

Press the MODE button to access the change status: “? 080”

Press the ARROW UP button to change the data: “? 081”

Press the MODE button to exit the change status: “= 081”

NOTE: Confirmation is requested before saving a change to any parameter:

????CONFIRMATION????

YES=MODE NO=RES

Answer YES to confirm, NO to reset the previous data.

5.5.1 Homepage – (WARN 33 shows that there is no power on the input terminals)



To perform a **MASTER RESET** keep the arrow up and arrow down button pressed for 6 seconds until figure 5.4.2 is displayed

To **CALIBRATE** press the **CAL + MODE + CAL** button as shown in figure 5.4.3.

For any **PARAMETER** access the submenu and search for the parameter to be changed as indicated in the table under paragraph 5.4.4.

5.5.2 Master Reset Page

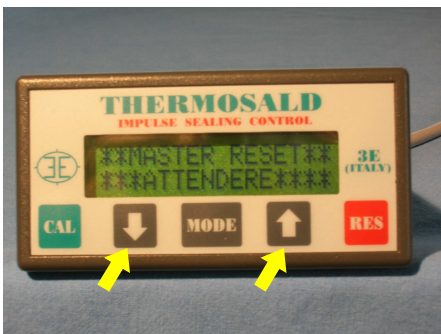

Using the Master Reset procedure the thermoregulator self-configures according to the hardware installed. The parameters are initialized as factory set: if a parameter has been changed, it must be returned to the working condition.

5.5.3 Calibration Page



Press **MODE** to access the calibration page

Press the **CAL** button to start calibration



5.5.4 PARAMETERS Pages (structure and notes of the parameters contained in the submenus)

Note: the parameters that are changed most frequently are indicated in red

TEMPERATURES	
PREHEAT TEMP.	We recommend you set it to 40° less than the sealing temp.
SEALING TEMP.	Sealing temperature
BALANCE TEMPERATURE	
THEORET. CALCULATIONS	
BAND WIDTH	Theoretical value to size the machine - not required for operation.
BAND THICKNESS	Theoretical value to size the machine - not required for operation.
WIRE DIAMETER	Theoretical value to size the machine - not required for operation.
BAND LENGTH	Theoretical value to size the machine - not required for operation.
NO. IN PARALLEL	Theoretical value to size the machine - not required for operation.
NO. IN SERIES	Theoretical value to size the machine - not required for operation.
OHM for SQ.MM / M	Theoretical value to size the machine - not required for operation.
AMPERE FOR SQ.MM	Theoretical value to size the machine - not required for operation.
DUTY CYCLE	Theoretical value to size the machine - not required for operation.
TECHNICAL ANALYSIS	
IMAX	Maximum RMS current (typical data of the thermoregulator model)
I2T	Integral current per time unit
I	Heating RMS current
THEORETICAL R	Theoretical resistance of the band (resulting from theoretical calculations)
R0	Calibration Resistance
R	RunTime Resistance
THEORETICAL I	Theoretical full-wave RMS current of the band (from theoretical calculations)
I0	Calibration full-wave RMS current
I	RunTime full-wave RMS current
THEORETICAL V	Theoretical full-wave RMS voltage of the band (from theoretical calculations)

V0	Calibration full-wave RMS voltage
V	RunTime full-wave voltage
THEORETICAL P	Theoretical full-wave power of the band $V \times I \times 0.7$ (from theoretical calculations)
P0	Calibration full-wave RMS power $V \times I \times 0.7$
P	RunTime full-wave RMS power $V \times I \times 0.7$
TEMP SENSOR ON	ON= precision sensor enabled
ACT. 1	ON= precision sensor active
TEMP	Precision Sensor Temperature
COMMANDS	
PREHEAT CMD	Manual control from the keyboard
SEALING CMD	Manual control from the keyboard
BURN IN CMD	Manual control from the keyboard
CMD IN CURRENT	Manual control from the keyboard
EMERGENCY TEST	
EMERGENCY TEST	Press the MODE button to check the emergency chain
SAVE CALIBRATION DATA	
SAVE CAL. DATA	Press the MODE button to save the data of the last calibration
TEMP.COEFF.(PPM)	
TEMP.COEFF.(PPM)	It is modified to adjust the thermoregulator to the material of the sealing band
CONFIGURATION	0=Impulse sealing (preset for extensions-do not change)
RESOLUTION	System resolution in bit/degree
MAX SEAL. TEMPERATURE	
MAX SEAL. TEMP.	It is modified to change the band's working temperature limits
FIELD BUS	
FIELD BUS	Parameters for the RS485 interface
SETTING DATA	
LANGUAGE SELECTION	Italian, English, French, German, Spanish, to be defined
DISPLAY DEGREES	see Appendix C, Setting Data List
MAX SEAL. TEMP.	see Appendix C, Setting Data List
G/SEC GRADIENT	see Appendix C, Setting Data List
GROUND CURRENT	see Appendix C, Setting Data List
WARN66 TIME	see Appendix C, Setting Data List
SET PAGE1 TEMP.	see Appendix C, Setting Data List
MACHINE DATA	
RATED I	see Appendix B, Machine Data List
RAMP	see Appendix B, Machine Data List
PROP. G. KV	see Appendix B, Machine Data List
INTEGRAL GAIN KI	see Appendix B, Machine Data List
INTEGRAL THRESHOLD	see Appendix B, Machine Data List
DERIVATIVE GAIN KD	see Appendix B, Machine Data List
PARTIAL SHORT	see Appendix B, Machine Data List
CIRCUIT FACTOR	
ALARM DISABL1	see Appendix B, Machine Data List
ALARM DISABL2	see Appendix B, Machine Data List
CONFIGURATION	see Appendix B, Machine Data List
TIMER ENABL.	see Appendix B, Machine Data List
TEMP SENSOR ENABL.	see Appendix B, Machine Data List
I2T X 1 SECOND	see Appendix B, Machine Data List
PASSWORD 1=P/2=T	see Appendix B, Machine Data List
KEY PASSWORD	see Appendix B, Machine Data List
INFORMATION	
3E s.r.l. – BO – ITALY	
CUSTOMER CARE	mail@3e3e3e.com
THERMOREG.MODEL	THERMOSALD ISX / IPX
THERMOREG.VERSION	Thermoregulator Software Release
DISPLAY VERSION	Panel Software Release

6 MAINTENANCE

6.1 REPLACING THE BAND WITH THE MACHINE COLD (i.e. bars at ambient temperature – scheduled maintenance)

- 1 – Power off, remove the preheat and sealing commands, let the gripper jaws cool down.
- 2 – Mount the new bands.
- 3 – Power on.
- 4 – Calibrate in order to compensate for any minor mechanical differences of the band (in most cases ambient temperature does not need to be changed in the setting data).
- 5 – THE MACHINE is ready to work.

6.2 REPLACING THE BAND WITH THE MACHINE HOT(i.e. bars at operating temperature - quick intervention)

- 1 – Power off, remove the preheat and sealing commands, let the gripper jaws cool down so the operator can work comfortably.
- 2 – Mount the new bands.
- 3 – Power on.
- 4 – If there are no great mechanical differences in the bands THE MACHINE is ready to work.

6.3 THERMOREGULATOR MAINTENANCE

To be scheduled according to the work environment, in any case with routine maintenance intervals should be no longer than 180 days.

- 1 – Make sure the connection terminals are properly screwed.
- 2 – Periodically check correct operation of the output safety alarm contact (press the mode button as requested at start-up to check the alarm circuit: the emergency output relay must open and the power circuit must remain disconnected).

6.4 GRIPPER JAWS MAINTENANCE

To be scheduled according to the work environment at periodic intervals.

- 1 – Make sure the feedback reference terminals and power terminals are properly screwed.
- 2 – Make sure the band's terminals are highly conductive and do not show any oxidation or bad contacts: if so, service them accurately.
- 3 – Check the band's supports in insulating material and Teflon.

7 TECHNICAL DATA

7.1 TECHNICAL DATA FOR THE MODULATION-ON-THE-SECONDARY MODEL

CONTROL POWER SUPPLY (CN2)	24VDC +/- 20% (max absorption: 0.3 A)
POWER SUPPLY CONTROL ON THE SECONDARY CONTROL ON THE PRIMARY	100VAC max (140VAC for HIVL model) 230-400VAC
60A MOD. SHORT CIRCUIT CURRENT	150 Ampere
90A MOD. SHORT CIRCUIT CURRENT	260 Ampere
MAINS FREQUENCY	50 – 60 Hz automatic switchover
DIGITAL COMMANDS	24 VDC (max absorption: 20 ma)
SEALING ALARM CONTACT	250 V 4 A
STANDARD RESOLUTION	0.3 degree
REPETITIVENESS	≅ +/- 1°C
PRECISION	Depend of the thermic drift of sealing band
PREHEATING TEMPERATURE	Can be set on the display panel, 0-300°C
SEALING TEMPERATURE	Can be set on the display panel, 0-300°C
SEALING AND COOLING-DOWN TIME	Internal with PLC Option
WORKING ENVIRONMENT TEMPERATURE	-40°C + 50°C
THERMOREGULATOR PROTECTION RATING	IP00
DISPLAY PANEL PROTECTION RATING	IP54 (IP65 upon request)
POWER UNIT WEIGHT	kg 1.6
PANEL WEIGHT	kg 0.2

8 ORDERING DATA

8.1 CODES FOR ORDERING

MODELS	Description	ORDERING CODE
THERMOSALD ISX-LC-60A	Impulse thermoregulator - low cost SECONDARY - 60 Ampere	3ES101S6V
THERMOSALD ISX-LC-90A	Impulse thermoregulator - low cost SECONDARY - 90 Ampere	3ES101S9V
THERMOSALD IPX-LC-230V	Impulse thermoregulator - low cost PRIMARY – 230Volts	3ES101P2V
THERMOSALD IPX-LC - 400V	Impulse thermoregulator - low cost PRIMARY – 400/480 Volts	3ES101P4V
THERMOSALD ISX-60A	Impulse thermoregulator - standard SECONDARY - 60 Ampere (3 levels)	3ES103S6V2
THERMOSALD ISX-90A	Impulse thermoregulator - Standard SECONDARY - 90 Ampere (3 levels)	3ES103S9V2
THERMOSALD ISX-60A-4L	Impulse thermoregulator - Standard SECONDARY - 60 Ampere (4 levels)	3ES104S6V2
THERMOSALD ISX-90A-4L	Impulse thermoregulator - Standard SECONDARY - 90 Ampere (4 levels)	3ES104S9V2
THERMOSALD ISX-60A-5L	Impulse thermoregulator - Standard SECONDARY - 60 Ampere (5 levels)	3ES105S6V2
THERMOSALD ISX-90A-5L	Impulse thermoregulator - Standard SECONDARY - 90 Ampere (5 levels)	3ES105S9V2
THERMOSALD IPX-230V	Impulse thermoregulator - standard PRIMARY - 230V (3 levels)	3ES103P2V2
THERMOSALD IPX-400V	Impulse thermoregulator - standard PRIMARY - 400-480V (3 levels)	3ES103P4V2
THERMOSALD IPX-230V-4L	Impulse thermoregulator - standard PRIMARY - 230V (4 levels)	3ES104P2V2
THERMOSALD IPX-400V-4L	Impulse thermoregulator - standard PRIMARY - 400-480V (4 levels)	3ES104P4V2
THERMOSALD IPX-230V-5L	Impulse thermoregulator - standard PRIMARY - 230V (5 levels)	3ES105P2V2
THERMOSALD IPX-400V-5L	Impulse thermoregulator - standard PRIMARY - 400-480V (5 levels)	3ES105P4V2
Precision Sensor Option	Bar temperature checking probe (+0 Levels)	3ES100Z=PROBE
High Volt Second. Option	Voltage on band: 100-140V(+0 Levels)	3ES100Z=HV
Low Volt Second. Option	Voltage on band: 3-10V(+0 Levels)	3ES100Z=LV
Low Volt Primary Option	Voltage on band: 3-10V(+0 Levels)	3ES100Z=LV

Coprocessor Option	Coprocessor (+1 Levels)	3ES100Z=COPRO
Analogue Option	Analogue inputs + 1 output (+1 Levels)	3ES100Z=AN
PLC Option	PLC+ Times (+1 Levels)	3ES100Z=PLC
Analogue+PLC Option	PLC+ Times+Analogue inputs (+1 Levels)	3ES100Z=ANPLC
RS485 Option	RS485 MODBUS Field bus (+1 Lev.)	3ES100Z=RS485
Profibus Option	PROFIBUS Field bus (+1 Levels)	3ES100Z=PROFI
Can bus Option	CAN Field bus (+1 Levels)	3ES100Z=CAN
Multilanguage Panel	Digital multilanguage panel for thermosald	3ES108V2 . . .
IP65 Option	IP65 protection (verify drilling template)	3ES108Z=IP65
Pan-rs485 Option	RS485 (being developed)	3ES108Z=RS485
Pan-adapter frame Option	Adjusting frame with UPSCR model	3ES108Z=COADA
Precision Sensor	External temperature sensor	3ES109B
CABLE	Panel-thermoregulator connection cable, 1 m	3ES080A001/1
CABLE	Panel-thermoregulator connection cable, 3 m	3ES080A001/3
CABLE	Panel-thermoregulator connection cable, 5 m	3ES080A001/5
CT	Current transformer	3ES080A002
Power transformer	Contact technical department for sizing	

Bands, Belts and sealing wires	Bands, belts and sealing wires with different profiles, in metres, specifically designed, copper-plated, Teflon-coated	
Installation and user manual in ITALIAN		3ES100_MDU_V2IT
Installation and user manual in ENGLISH		3ES100_MDU_V2EN
Installation and user manual in FRENCH		3ES100_MDU_V2FR
Installation and user manual in GERMAN		3ES100_MDU_V2DE
Installation and user manual in SPANISH		3ES100_MDU_V2SP
RS485 manual in ITALIAN		3ES100_485_IT
Profibus manual in ITALIAN		3ES100_PRO_IT
Can Bus Manual in ITALIAN		3ES100_CAN_IT

8.2 SUGGESTIONS FOR CHOOSING THE MODEL

- Use model I=60A for a total band cross-section $\leq 2\text{sq.mm}$
- Use model I=90A for a total band cross-section $> 2\text{sq.mm}$
- Use model HV for transformer V voltage $> 100\text{Vac}$
- Use model LV for transformer V voltage $< 10\text{Vac}$
- All the options can be applied to standard models ISX2 and IPX2

8.3 POSSIBLE CONFIGURATIONS

- 3-LEVEL STRUCTURE – All basic models
- 4-LEVEL STRUCTURE - RS485 / PROFI / CAN Option
- 5-LEVEL STRUCTURE - Options
 - AN / PLC / ANPLC / COPRO
 - AN+COPRO / PLC+COPRO / ANPLC+COPRO
 - RS485+COPRO / RS485+AN / RS485+PLC / RS485+ANPLC
 - PROFI+COPRO / PROFI+AN / PROFI+PLC / PROFI+ANPLC
 - CAN+COPRO / CAN+AN / CAN+PLC / CAN +ANPLC

8.4 ORDER EXAMPLES

PRODUCT NAME	ORDERING CODE
(order for thermoregulator, standard, second. 60A – 3 Levels) THERMOSALD ISX-60°	3ES103S6V2 . . .
(order for multilanguage panel) Multilanguage Panel	3ES108V2 . . .
(order for thermoregulator, standard, secondary 90A – 3 Levels) + Profibus Option, 1 Level + Coprocessor Option, 1 Level / Total of 5 Levels) THERMOSALD ISX-90A-5L	3ES105S9V2 . . .
Profibus Option	3ES100Z=PROFI
Coprocessor Option	3ES100Z=COPRO
(order for thermoregulator, standard, secondary 90A – 3 Levels) + Analogue+PLC Option, 1 Level / Total of 4 Levels + Panel + User Manual in Italian) THERMOSALD ISX-90A-4L	3ES104S9V2 . . .
Analogue+PLC Option	3ES100Z=ANPLC
Multilanguage Panel	3ES108V2 . . .
Installation and user manual in ITALIAN	3ES100_MDU_V2IT

(order for thermoregulator, standard, primary 400V + Analogue Option, 1 Level + Coprocessor Option, 1 Level / Total of 5 Levels + Multilanguage Panel + User Manual in English) THERMOSALD IPX-400V-5L	3ES105P4V2 . . .
Coprocessor Option	3ES100Z=COPRO
Analogue Option	3ES100Z=AN
Multilanguage Panel	3ES108V2 . . .
Installation and user manual in ENGLISH	3ES100_MDU_V2EN

APPENDIX A – SEALING CYCLE

NOTE - The sealing cycle suggested is given by way of example only and is not to be considered as a binding usage diagram. Experience shows that the timing must be changed according to the specific application, i.e. of the materials, dimensions, times, etc. For further information please contact our technical department.

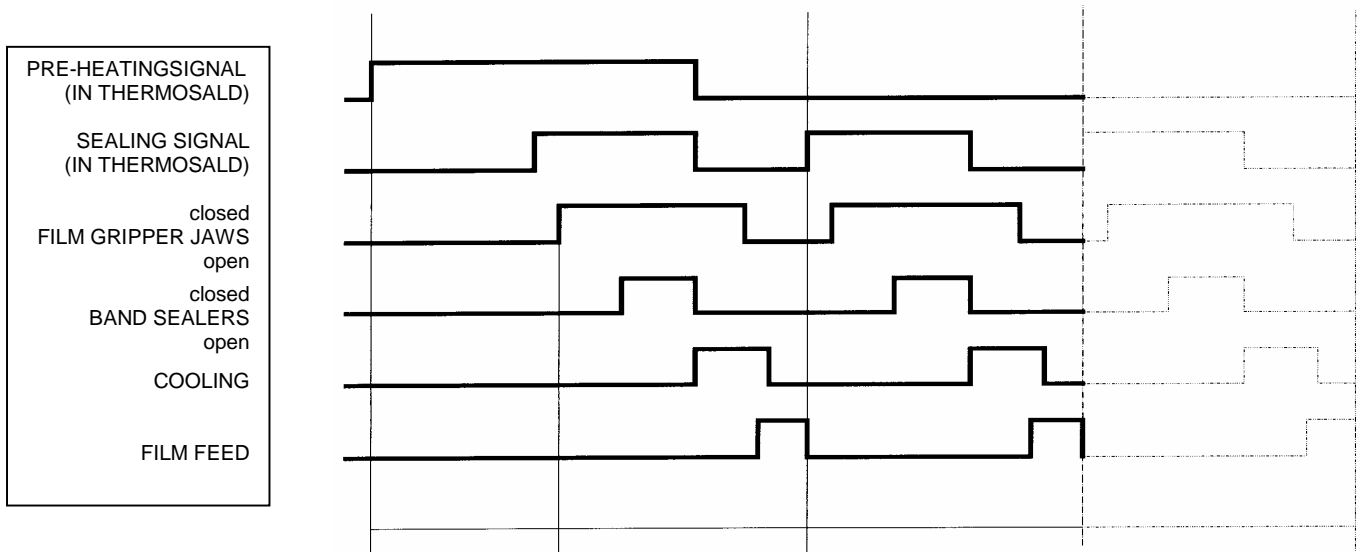

APPENDIX B - MACHINE DATA LIST

NOTE – The machine data must be changed only by skilled and qualified personnel after contacting our technical department

TO ACCESS: press the **MODE** button on the **MACHINE DATA** submenu

TO EXIT: press the **RES** button

RATED I = 60 / 90 / 120 (AMPERE)

Cannot be changed, it shows the rated current of the model used

HEATING RAMP = (U.M. = degrees/100ms, default = 40)

Temperature increase rate following a preheat or sealing command [U.M. : degrees/100 ms]. Increasing this parameter means decreasing the time required to bring the band to the proper temperature, subsequently increasing speed, reducing stability, decreasing band life.

PROPORTIONAL GAIN KV = (U.M., default = 100)

Proportional loop gain. Increasing this parameter means increasing the loop reply speed and therefore making the system more ready.

Increasing it too much may result in system instability and subsequently in temperature oscillation.

INTEGRAL GAIN KI = (U.M., default = 100)

Integral loop gain. Increasing this parameter means increasing temperature accuracy and the speed for achieving the temperature desired. Increase this parameter to increase system stability.

Increasing it too much may result in a temperature overflow subsequent to a preheat or sealing command.

INTEGRAL THRESHOLD LIMIT = (% , default = 60)

It limits the maximum value of the integrative component: increasing this value increases the cold overshoot

DERIVATIVE GAIN KD = (U.M., default = 50)

Derivative loop gain. Increasing this parameter means increasing the loop reply speed and therefore making the system more ready to changes.

Increasing it too much may result in system instability and subsequently in temperature oscillation.

PARTIAL SHORT CIRCUIT FACTOR = (U.M. , default = 1.2)

It allows an instantaneous current threshold to be established, due to a partial short circuit, above which the thermoregulator goes in alarm condition F097.

ALARM DISABLING1 = 0 (U.M.)

It allows any alarm to be disabled. To be used carefully. In certain cases it may allow the production cycle to restart. Alarm disabling must be considered temporary and actions must be taken immediately to remove its causes.

ALARM DISABLING2 = 0 (U.M.)

It allows any alarm to be disabled. To be used carefully. In certain cases it may allow the production cycle to restart. Alarm disabling must be considered provisional and actions must be taken immediately to remove its causes.

DISPLAY CONFIGURATION = 2

1=operation with potentiometers: the temperature set on the display can be limited by the analogue input.

2=operation with display only.
TIMER ENABLING (default = OFF) It is put to ON when the PLC card is plugged in, for managing sealing gripper jaw movement and sealing times
TEMPERATURE SENSOR ENABLING (ON/OFF) It is automatically acquired during the MASTER RESET
PASSWORD ENABLING = 0 1=partial password; 2=total password
KEY PASSWORD (default = 0000) Another password can be entered to block the data

APPENDIX B1 – PRIORITY MACHINE DATA managed directly on the MAIN MENU

BALANCE TEMPERATURE (default = 30) It can be changed according to the ambient temperature during calibration; with the PRECISION SENSOR option this parameter is changed automatically at the end of a calibration procedure
TEMPERATURE COEFFICIENT (ppm – parts per million, default =1210) It allows the thermoregulator to be adjusted to the type of band used. See safety standards in this manual. The value required is to be set again after a MASTER RESET.
CONFIGURATION (default =0) Do not change this parameter.
MAX Sealing TEMPERATURE (default = 250) It can be changed according to the maximum temperature allowed. The value required is to be set again after a MASTER RESET.
I2T for 1 SECOND (default = 200 Ampere) It can be decreased according to the protection rating desired on the machine

APPENDIX C - SETTING DATA LIST

NOTE – The machine data must be changed only by skilled and qualified personnel after contacting our technical department.

TO ACCESS: press the **MODE** button on the **SETTING DATA** submenu

TO EXIT: press the **RES** button

LANGUAGE SELECTION

It is possible to select up to 6 languages: ITALIAN, ENGLISH, FRENCH, GERMAN, SPANISH, TO BE DEFINED

DISPLAY DEGREES

It allows the user to select whether the temperature is to be displayed in Celsius or Fahrenheit degrees.

MAXIMUM SEALING TIME (SECONDS, default = 0.0)

Sealing time check. It allows the maximum time of the sealing command to be set. If the sealing command lasts longer than this value, the thermoregulator goes in alarm condition F085.

For applications with a sealing command that is always high, this parameter must be set to 0.

TEMPERATURE GRADIENT FOR BALANCE (DEGREES/10 SECONDS, default = 4)

It shows the maximum temperature cooling down speed expressed in degrees/10 seconds above which the balance is not enabled and warning 38 appears. Increasing this parameter may result in a loss of accuracy.

GROUND CURRENT (ma, default = 1000 ma)

It can be changed

WARN66 TIME = (SECONDS, default = 3)

In the case of mains with unstable frequency due to connecting power factor correction units on line, the thermoregulator signals the failure without going to an alarm condition and stopping. The message is displayed for the seconds specified by this parameter.

SET PAGE1 TEMP. (default = 0)

It allows the sealing temperature to be changed directly on the main page using the ARROW UP and ARROW DOWN buttons

APPENDIX D – LIST OF ALARMS AND MESSAGES (CAUSES – REMEDIES)

NOTE – To reset any alarm raise the RESET command from the interface and press the **RESET / MODE** button

NOTE – When in the alarm condition the RED LED lights up; the alarm number can be deducted from the green and red LED blinking:
ALARM NO.=NO. OF GREEN LED IMPULSES x 10 + NO. OF RED LED IMPULSES

NOTE – When in the warning condition the YELLOW LED lights up; the warning number can be deducted from the green and red LED blinking:
WARNING NO.=NO. OF GREEN LED IMPULSES x 10 + NO. OF RED LED IMPULSES

ALARM	DESCRIPTION	REMEDY
FAULT A	thermoregulator completely OFF plus display completely OFF	Check the power supply; power supply unit faulty; contact the supplier
FAULT C	THERMOREGULATOR WITH LED OPERATING AND DISPLAY ON SHOWING "3E SRL + THERMOSALD"	Check the display connection cable
F001	EEPROM WRITING INTERRUPTED	Switch the equipment OFF and then ON; then contact the supplier
F002	EEPROM WRITING WITH PREVIOUS OPERATION IN PROGRESS	Switch the equipment OFF and then ON; then contact the supplier
F003	EEPROM WRITING WITH FAULTY EEPROM	Switch the equipment OFF and then ON; then contact the supplier
F006	PANEL FLASH EEPROM WRING	Switch the equipment OFF and then ON; then contact the supplier
F007	A/D CONVERTER –CONVERTER WRITING ERROR	Switch the equipment OFF and then ON; then contact the supplier
F008	INTERNAL I2C-X TRANSMISSION	Switch the equipment OFF and then ON
F009	DO NOT USE	
F010	A/D CONVERTER –CHANNEL SELECTION ERROR	Switch the equipment OFF and then ON; then contact the supplier
F011	COPROCESSOR SELECTOR ON WITH COPRO CARD NOT ACTIVE OR SEL. COPRO OFF WITH COPRO CARD ACT.	Coprocessor card problems; perform a Master Reset and contact the supplier

F012	INTERNAL BUS CARD TRANSMISSION	Switch the equipment OFF and then ON; then check the parameters
F013	INTERNAL COPROCESSOR CARD TRANSMISSION	Switch the equipment OFF and then ON; then check the parameters
F019	RS485 MASTER - CHECKSUM ERROR	Check checksum selection on the Master and Slave
F020	RS485 SLAVE - CHECKSUM ERROR	Check checksum selection on the Master and Slave
F021	RS485 SLAVE - OE OVERRUN ERROR	Data have arrived before finishing reading the previous ones
F022	RS485 SLAVE - FERR FRAME ERROR	Stop bit has not arrived
F023	RS485 MASTER – NO REPLY FROM SLAVE	After a call of the Master the called Slave does not reply
F024	RS485 SLAVE – TOO MUCH DATA REQUESTED BY THE MASTER OR INCORRECT ADDRESS	The Master has asked the Slave for too much data or issued an address that is not enabled
F025	RS485 SLAVE - BUFFER FULL	The buffer of the slave is full because too much data have been requested or arrived or transmissions are too frequent
F026	RS485 MASTER - OE OVERRUN ERROR	Data have arrived before finishing reading the previous ones
F027	RS485 MASTER - FERR FRAME ERROR	Stop bit has not arrived
F028	RS485 MASTER – TOO MUCH DATA REQUESTED BY THE SLAVE OR INCORRECT ADDRESS	The Slave has asked the Master for too much data or issued an address that is not enabled
F029	RS485 MASTER - BUFFER FULL	The buffer of the Master is full because too much data have arrived
F033	WARNING: no VOLTAGE IN THE POWER TRANSFORMER OR BAND NOT CONNECTED	Check the CN1/L1,L2 power supply, the power transformer circuit, check connection of the power cables on the band.
F034	DO NOT USE	
F035	WARNING – CALIBRATION REQUEST STATUS	It is used in the RS485 remote control
F036	WARNING – STATUS OF CALIBRATION IN PROGRESS	It is used in the RS485 remote control to check the end of calibration
F037	EXTERNAL TEMPERATURE PROBE NOT ACTIVE	Check temperature probe connection or TEMPERATURE PROBE Enabling machine data
F038	WARNING – Waiting for machine to cool down upon calibration request	To perform a calibration procedure it is necessary to wait until the sealing bar reaches a stable temperature.

F039	WARNING – Sealing out of range	No power for the first sealing
F046	NO CURRENT SIGNAL	Check CT connection and band power cable connections
F047	CT SIGNAL REVERSED	Reverse CT connection
F048	PREHEAT POTENTIOMETER NOT CONNECTED OR CABLES INTERRUPTED	Check preheat potentiometer connections
F049	SEALING POTENTIOMETER NOT CONNECTED OR CABLES INTERRUPTED	Check sealing potentiometer connections
F051	WIPER-IGROSS	Switch the equipment OFF and then ON; if the problem persists, contact the supplier
F052	WIPER-VGROSS	Switch the equipment OFF and then ON; if the problem persists, contact the supplier
F053	WIPER-IFINE	Switch the equipment OFF and then ON; if the problem persists, contact the supplier
F054	WIPER-VFINE	Switch the equipment OFF and then ON; if the problem persists, contact the supplier
F060	RESET WITH CALIBRATION IN PROGRESS	Repeat calibration
F061	IGROSS BALANCE NOT SUCCESSFUL	Repeat calibration
F062	VGROSS BALANCE NOT SUCCESSFUL	Verify if Band +/- Ref connected together; Verify if voltage power transf. is right; Repeat calibration
F063	IFINE BALANCE NOT SUCCESSFUL	Repeat calibration
F064	VFINE BALANCE NOT SUCCESSFUL	Repeat calibration
F065	SUPERFINE BALANCE NOT SUCCESSFUL	Repeat calibration
F066	WARNING: SYNCHRONISM DUE TO MAINS FREQUENCY OSCILLATION - MAINS SYNCHRONISM INTERFERENCE	Verify connection power transformer and Main Frequency
F069	GROUND CURRENT	Check the band on the machine or the band connection, probably grounded. NOTE: the thermoregulator is grounded via a ground screw, the band wires must therefore be disconnected before checking using an electrical instrument.
F071	HARDWARE FAULT – ANALOGUE +/-15V BREAKAGE	Reset the equipment; if the problem persists, contact the supplier
F072	HARDWARE FAULT – ANALOGUE +/-5V BREAKAGE	Reset the equipment; if the problem persists, contact the

		supplier
F073	HARDWARE FAULT – REFERENCE +5V BREAKAGE	Reset the equipment; if the problem persists, contact the supplier
F074	INTERNAL TEMPERATURE PROBE – HEAT SINK TEMPERATURE TOO HIGH	Switch the equipment OFF; if the problem persists, contact the supplier
F075	WARNING INTERRUPT FIRE BLOCK	Verify connection power transformer and Main Frequency
F076	IREAD TOO HIGH	Check if there is a short circuit on the bands
F077	MANUAL CMD FROM THE PANEL NOT ACTIVE DUE TO PREHEAT OR SEALING FROM OUTSIDE	Remove the preheat and sealing before giving the command
F078	EQUIPMENT NOT CALIBRATED	Perform the automatic calibration procedure without giving the preheat or sealing command
F079	EMERGENCY CIRCUIT FAULT	Check the power contactor, check the emergency chain
F080	BACK_FIRE TIMER CONTROL	Reset the equipment; if the problem persists, contact the supplier
F081	HARDWARE FAULT – CHECKSUM ALARM	Inconsistent data have been found on eeprom, proceed carefully Press RESET/MODE, check MACHINE DATA, SETTING DATA and TEMPERATURES set. Contact the supplier
F082	phase displacement between power (CN1) and control power supply (CN2) – only primary model	Make sure the two power supplies are in phase (pay attention to the phase-phase/phase-neutral phase displacement)
F083	REFERENCE CABLES REVERSED WITH RESPECT TO THE POWER CABLES	Check the reversed reference cables: CN1/3 corresponds to CN6/1 CN1/4 corresponds to CN6/2
F085	SEALING TIME HIGHER THAN THE SEALING TIME MACHINE DATA	Check the sealing time on the SEALING TIME MACHINE DATA; the sealing time control can be excluded by setting the SEALING TIME MACHINE DATA = 0
F089	BREAK OF A BAND IN CASE OF BANDS CONNECTED IN PARALLEL	Check the bands
F090	SHORT CIRCUIT BETWEEN THE BANDS OR BETWEEN THE BANDS AND	Check the bands, check power cabling between the

	GROUND	thermoregulator and bands
F091	I2T CURRENT TOO HIGH ALARM	Check the band on the machine or the band connections. Power delivered too high
F092	POWER COMPONENT FAULTY	Reset the equipment; if the problem persists, contact the manufacturer
F093	NO CURRENT ON THE BAND USED FOR SEALING	Check the power transformer, check for any interruption of the band, check for any interruption of the power cables
F094	REFERENCE CABLE INTERRUPTION	Check the reference cables (CN6/1 - CN6/2)
F095	NO MAINS SYNCHRONISM – NOT ACTIVE IN THE ISX-IPX MODELS	Internal hardware problem. Contact the manufacturer
F096	V-I TOO HIGH - NOT ACTIVE IN THE ISX-IPX MODELS	Saturation on the voltage circuit; check the system, probably a band broke if it is connected in parallel
F097	PARTIAL SHORT CIRCUIT BETWEEN THE BANDS	Check the bands on the machine, Probably they are not insulated correctly. If the band is fine and the problem persists, let the machine cool down and calibrate. Pay attention to the machine's behaviour in the subsequent working phases. To remove the problem the PARTIAL SHORT CIRCUIT FACTOR MACHINE DATA can also be raised.
F099	ALARM UNKNOWN	Contact the manufacturer
F100	NOT USED	
F101	COPROCESSOR EEPROM WRITING INTERRUPTED	Switch the equipment OFF and then ON; then contact the supplier
F102	COPROCESSOR EEPROM WRITING WITH PREVIOUS OPERATION IN PROGRESS	Switch the equipment OFF and then ON; then contact the supplier
F103	COPROCESSOR EEPROM WRITING WITH FAULTY EEPROM	Switch the equipment OFF and then ON; then contact the supplier
F107	COPROCESSOR A/D CONVERTER – CONVERTER WRITING ERROR	Switch the equipment OFF and then ON; then contact the supplier
F108	INTERNAL I2C-X TRANSMISSION COPROCESSOR	Switch the equipment OFF and then ON
F109	DO NOT USE	

F110	COPROCESSOR A/D CONVERTER – CHANNEL SELECTION ERROR	Switch the equipment OFF and then ON; then contact the supplier
F133	COPROCESSOR WARNING - NO VOLTAGE IN THE POWER TRANSFORMER OR BAND NOT CONNECTED	Check the CN1/L1,L2 power supply, check the power transformer circuit, check the power cable connection on the band
F134	DO NOT USE	
F137	COPROCESSOR EXTERNAL TEMPERATURE PROBE NOT ACTIVE	Check the temperature probe connection or COPROCESSOR TEMPERATURE PROBE Enabling machine data
F138	WARNING – WAITING FOR MACHINE TO COOL DOWN	To perform a calibration procedure it is necessary to wait until the sealing bar reaches a stable temperature.
F143	COPROCESSOR BASIC TEMPERATURE <> COPROCESSOR TEMPERATURE	Verify CT cables of coprocessor and processor; possible connection defective
F144	COPROCESSOR BASIC TEMPERATURE > COPROCESSOR TEMPERATURE+10 (FOR 500 MS)	Proceed carefully; calibrate, check the coprocessor open CT cables; contact the supplier
F145	COPROCESSOR TEMPERATURE > BASIC TEMPERATURE+10 (FOR 500MS)	Proceed carefully; calibrate, check the processor open CT cables; contact the supplier
F146	COPROCESSOR - NO CURRENT SIGNAL	Check the CT connections and band power cable connections
F147	COPROCESSOR CT SIGNAL REVERSED	Reverse the CT connection
F151	COPROCESSOR WIPER-IGROSS	Switch the equipment OFF and then ON; if the problem persists, contact the supplier
F152	COPROCESSOR WIPER-VGROSS	Switch the equipment OFF and then ON; if the problem persists, contact the supplier
F153	COPROCESSOR WIPER-IFINE	Switch the equipment OFF and then ON; if the problem persists, contact the supplier
F154	COPROCESSOR WIPER-VFINE	Switch the equipment OFF and then ON; if the problem persists, contact the supplier
F160	COPROCESSOR RESET WITH CALIBRATION IN PROGRESS	Repeat calibration
F161	COPROCESSOR IGROSS BALANCE NOT SUCCESSFUL	Repeat calibration
F162	COPROCESSOR VGROSS BALANCE NOT SUCCESSFUL	Repeat calibration
F163	COPROCESSOR IFINE BALANCE NOT	Repeat calibration

	SUCCESSFUL	
F164	COPROCESSOR VFINE BALANCE NOT SUCCESSFUL	Repeat calibration
F165	COPROCESSOR SUPERFINE BALANCE NOT SUCCESSFUL	Repeat calibration
F166	COPROCESSOR WARNING: SYNCHRONISM DUE TO MAINS FREQUENCY OSCILLATION - MAINS SYNCHRONISM INTERFERENCE	Verify connection power transformer and Main Frequency
F167	COPROCESSOR TEMPERATURE > MAXIMUM TEMPERATURE (FOR 600MS)	Proceed carefully; check the preheat and sealing temperatures; check the maximum temperature parameter; contact the supplier
F168	COPROCESSOR TEMPERATURE > BASIC TEMPERATURE+10	Proceed carefully; check the preheat and sealing temperatures; check the maximum temperature parameter; contact the supplier
F169	COPROCESSOR GROUND CURRENT	Check the band on the machine or the band connection, probably grounded. NOTE: the thermoregulator is grounded via a ground screw, the band wires must therefore be disconnected before checking using an electrical instrument.
F170	COPROCESSOR READ=0 WITH PHASE OPEN AND HIGH CURRENT	Current passes without any reading enable signal; contact the supplier
F171	COPROCESSOR HARDWARE FAULT – ANALOGUE +/-15V BREAKAGE	Reset the equipment; if the problem persists, contact the supplier
F172	COPROCESSOR HARDWARE FAULT – ANALOGUE +/-5V BREAKAGE	Reset the equipment; if the problem persists, contact the supplier
F173	COPROCESSOR HARDWARE FAULT – REFERENCE +5V BREAKAGE	Reset the equipment; if the problem persists, contact the supplier
F174	COPROCESSOR INTERNAL TEMPERATURE PROBE – HEAT SINK TEMPERATURE TOO HIGH	Switch the equipment OFF; if the problem persists, contact the supplier
F175	COPROCESSOR WARNING INTERRUPT FIRE BLOCK	Verify connection power transformer and Main Frequency
F176	COPROCESSOR IREAD TOO HIGH	Check if there is a short circuit on the bands
F178	COPROCESSOR NOT CALIBRATED	Calibrate
F179	COPROCESSOR DON'T RECEIVE FROM	Reset the equipment; if the

	MASTER INTERNAL TRANSMISSION DATA BUS	problem persists, contact the supplier
F180	COPROCESSOR SYNCHRONISM NOT RECEIVED	Reset the equipment; if the problem persists, contact the supplier
F181	COPROCESSOR - CHECKSUM ALARM – DATA ON EEPROM INCONSISTENT	Proceed carefully; Press RESET/MODE, check MACHINE DATA, SETTING DATA and TEMPERATURES set. Contact the supplier
F182	COPROCESSOR AND BASIC TEMPERATURE ENABLING INCONSISTENT	Make sure both temperature probes are connected or disconnected; then perform a MASTER RESET to acquire
F183	COPROCESSOR REFERENCE CABLES REVERSED WITH RESPECT TO THE POWER CABLES	Check the reversed reference cables: CN1/3 corresponds to CN6/1 CN1/4 corresponds to CN6/2
F184	COPROCESSOR SEALING COMMAND INCONSISTENT WITH BASIC (INTERNAL CONTROL)	Switch the equipment OFF and then ON; if the problem persists, contact the supplier (Coprocesor does not receive CO_SALD_IN_ACT from base)
F0185	SEALING TIME HIGHER THAN THE SEALING TIME MACHINE DATA	Check the sealing time on the SEALING TIME MACHINE DATA; the sealing time control can be excluded by setting the SEALING TIME MACHINE DATA = 0
F190	COPROCESSOR SHORT CIRCUIT BETWEEN THE BANDS OR BETWEEN THE BANDS AND GROUND	Check the bands, check the power cabling between the thermoregulator and bands
F191	COPROCESSOR I2T CURRENT TOO HIGH ALARM	Check the band on the machine or the band connections. Power delivered too high
F193	COPROCESSOR NO CURRENT ON THE BAND USED FOR SEALING	Check the power transformer, check for any interruption of the band, check for any interruption of the power cables
F194	COPROCESSOR REFERENCE CABLE INTERRUPTION	Check for any interruptions in the reference cables (CN6/1 - CN6/2)
F195	COPROCESSOR NO MAINS SYNCHRONISM, NOT ACTIVE IN THE ISX-IPX MODEL	Internal hardware problem. Contact the manufacturer
F196	COPROCESSOR V-I TOO HIGH, NOT ACTIVE IN THE ISX-IPX MODEL	Saturation on the voltage circuit; check the system, probably a band broke if it is connected in parallel

F197	COPROCESSOR PARTIAL SHORT CIRCUIT BETWEEN THE BANDS	Check the bands on the machine, Probably they are not insulated correctly. If the band is fine and the problem persists, let the machine cool down and calibrate. Pay attention to the machine's behaviour in the subsequent working phases. To remove the problem the PARTIAL SHORT CIRCUIT FACTOR MACHINE DATA can also be raised.
F199	COPROCESSOR ALARM UNKNOWN	Contact the supplier

APPENDIX E – MECHANICAL DIMENSIONS

DIGITAL PANEL: 96x48 – REAR DIMENSIONS: 90.5x44.5
DEPTH = 73mm + Connector 52mm

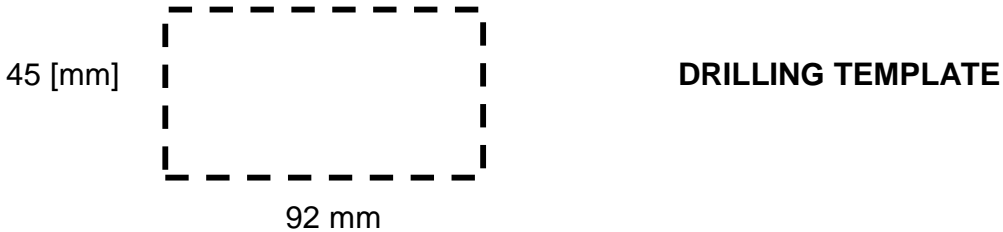

NOTE: with IP65 protection, code 3ES108Z=IP65, do drilling template 94mm x 47mm, Maximum external size 102mm x 54mm

THERMOREGULATOR DIMENSIONS

100 x 120 (VIEW FROM TOP)

HEIGHT = 135mm (3 Levels model) / 155mm (4 Levels model) / 175mm (5 Levels model)

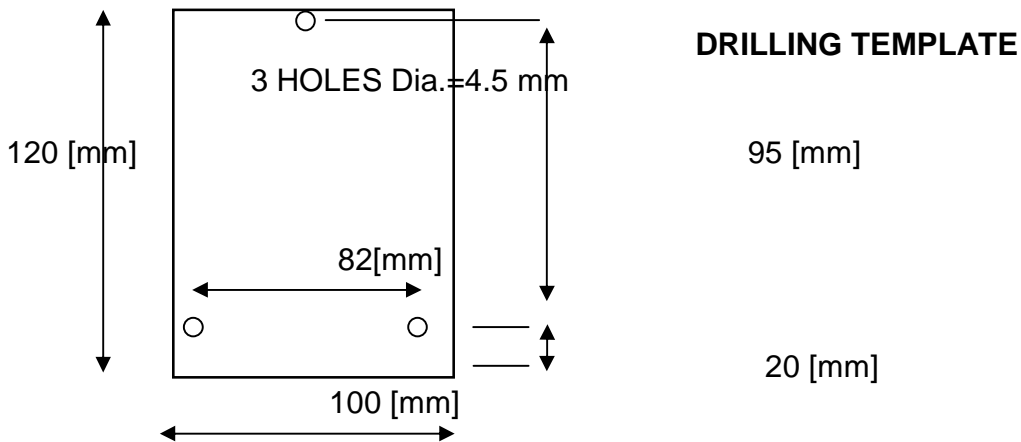

APPENDIX F – TABLE OF BANDS

TABLE OF THE CHAMFERED BANDS IN SPECIAL ALLOY
 (Band extension 50PPM, 0.05mm/metre per degree – 5mm/metre per 100 degrees)

Band Width (mm)	Band Thickness (mm)	Specific Resistance R0 Ω / m
1.5	0.3	1.67
2	0.25	1.59
3	0.1	2.95
3	0.15	1.95
3	0.2	1.50
3	0.25	1.27
4	0.15	1.40
4	0.25	0.96
5	0.2	0.8
5	0.25	0.69
6	0.1	1.6
6	0.2	0.72
8	0.1	1.2
8	0.2	0.51

TABLE OF THE T-SHAPE BANDS IN SPECIAL ALLOY

Band Width (mm)	Band Thickness (mm)	Specific Resistance R0 Ω / m
2.8	0.3	0.9
4	0.3	0.6

TABLE OF THE BEADED ELEMENT BANDS IN SPECIAL ALLOY

Band Width (mm)	Band Thickness (mm)	Specific Resistance R0 Ω / m
4	0.15	1.4
4	0.25	0.9
6	0.15	0.99
6	0.25	0.6

TABLE OF THE CONCAVE BANDS IN SPECIAL ALLOY

Band Width (mm)	Band Thickness (mm)	Specific Resistance R0 Ω / m
2.8	0.3	0.9

